

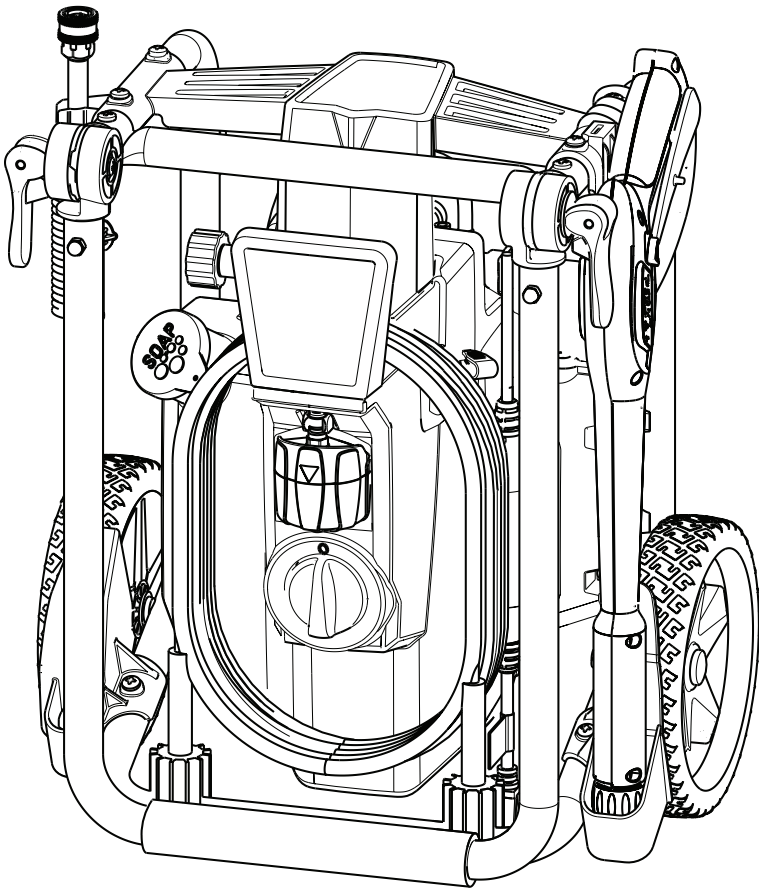

# Electric Pressure Washer Operator's Manual



Model Number \_\_\_\_\_

Revision \_\_\_\_\_

Serial Number \_\_\_\_\_

Date Purchased \_\_\_\_\_

For more information visit [www.refurbproductsupport.com](http://www.refurbproductsupport.com)

**Thank you** for purchasing this quality-built Murray® electric pressure washer. We are pleased that you've placed your confidence in the Murray brand. When operated and maintained according to the instructions in this manual, your Murray electric pressure washer will provide many years of dependable service.

**This manual contains** safety information to make you aware of the hazards and risks associated with electric pressure washers and how to avoid them. Because Murray does not necessarily know all the applications this electric pressure washer could be used for, it is important that you read and understand these instructions thoroughly before attempting to start or operate this equipment. **Save these original instructions for future reference.**

**This electric pressure washer requires final assembly before use.** Refer to the *Assembly* section of this manual for instructions on final assembly procedures. Follow the instructions completely.

## Where to Find Us

You never have to look far to find support and service for your electric pressure washer, just visit [www.refurbproductsupport.com](http://www.refurbproductsupport.com)

## Register Your Product

Register your product online at [www.refurbproductsupport.com](http://www.refurbproductsupport.com)

## Table of Contents

Operator Safety . . . . .	3
Assembly . . . . .	6
Features and Controls . . . . .	8
Operation . . . . .	9
Maintenance . . . . .	12
Storage . . . . .	13
Troubleshooting . . . . .	14
Specifications . . . . .	14

# Operator Safety

## SAVE THESE INSTRUCTIONS

### Equipment Description



**WARNING** Failure to read and follow the operator's manual and all operating instructions before using could result in death or serious injury.

- Read this manual carefully and become familiar with your electric pressure washer. Know its applications, its limitations, and any hazards involved.

This electric pressure washer operates at a maximum of 2,000 PSI (138 BAR) and a flow rate of up to 1.2 GPM (4.5 liters/min).

Every effort has been made to ensure that the information in this manual is accurate and current. However, we reserve the right to change, alter, or otherwise improve the product and this document at any time without prior notice. This ISM device complies with Canadian ICES-001.

### Ground Fault Circuit Interrupter Protection

This pressure washer is provided with a ground-fault circuit-interrupter (GFCI) built into the plug of the power supply cord. This device provides additional protection from the risk of electric shock. Should replacement of the plug or cord become necessary, use only identical replacement parts that include GFCI protection.

### Grounding Instructions

This product must be grounded. If it should malfunction or breakdown, grounding provides a path of least resistance for electric current to reduce the risk of electric shock. This product is equipped with a cord having an equipment-grounding conductor and a grounding plug. The plug must be plugged into an appropriate outlet that is properly installed and grounded in accordance with all local codes and ordinances. **DANGER** – Improper connection of the equipment-grounding conductor can result in a risk of electrocution. Check with a qualified electrician or service personnel if you are in doubt as to whether the outlet is properly grounded. Do not modify the plug provided with the product – if it will not fit the outlet, have a proper outlet installed by a qualified electrician. Do not use any type of adaptor with this product.

### Automatic Shut-Off

The electric pressure washer is equipped with a sensor that will detect that water flow has stopped when releasing the spray gun trigger. The sensor will cause the motor to shut off for as long as the spray gun trigger is released. If the motor continues to run when the spray gun trigger is released, **DO NOT USE THE MACHINE**. Call the electric pressure washer helpline at **1-855-566-9776** for assistance.

**NOTICE** The electric pressure washer is equipped with a main power ON/OFF switch. The switch should always be moved to the OFF position (0) when the electric pressure washer is not being used to prevent possible damage.

### Motor Overload

The electric motor in this electric pressure washer is equipped with an overload protection device (thermostat). This device will automatically shut off the motor if the motor overheats or draws excessive current.

If the overload protection device is tripped, disconnect the power supply by turning the master ON/OFF switch to the OFF (0) position. Let unit cool for 30 minutes. Then turn the master ON/OFF switch to the ON (I) position to resume operation.

### Important Safety Information

Please read and understand this entire manual before attempting to assemble, operate or service the product. Follow the maintenance instructions specified in this manual. If you have any questions regarding the product, please call customer service at **1-855-566-9776**, 8 a.m. - 5 p.m., CST, Monday - Friday.

### Safety Symbols and Meanings



Read Manual



Electrical Shock



Fire



Slippery Surface



Fall



Fluid Injection



Projectile



Flying Objects



Chemical Burn

**⚠** The safety alert symbol indicates a potential personal injury hazard. A signal word (**DANGER**, **WARNING**, or **CAUTION**) is used with the alert symbol to designate a degree or level of hazard seriousness. A safety symbol may be used to represent the type of hazard. The signal word **NOTICE** indicates information considered important, but not hazard-related.

**⚠ DANGER** indicates a hazard which, if not avoided, *will* result in death or serious injury.

**⚠ WARNING** indicates a hazard which, if not avoided, *could* result in death or serious injury.

**⚠ CAUTION** indicates a hazard which, if not avoided, *could* result in minor or moderate injury.



**NOTICE** indicates information considered important, but not hazard-related.

 **WARNING** Risk of electrocution. Use of an extension cord could cause electric shock or burn resulting in death or serious injury.



- DO NOT use an extension cord with this electric pressure washer. Your home's electrical circuit receptacle or extension cord may not provide lifesaving ground-fault circuit-interruption protection.

 **WARNING** Risk of electrocution. Contacting both power conductors, at the same time could cause electric shock or burn resulting in death or serious injury.

- Connect only to a properly grounded outlet. DO NOT remove ground pin from plug.
- Inspect cord before each use, DO NOT use if cord is damaged.
- The product is equipped with a ground fault circuit interrupter (GFCI) built into the power cord plug. If replacement of the plug or cord is required, use only identical replacement parts.
- Keep all connections dry and off the ground.
- DO NOT touch plug with wet hands.
- DO NOT run cord through doorways, windows, holes in ceilings, walls, or floors.
- DO NOT walk on cord.
- DO NOT drive over, drag or place objects over cord.
- DO NOT spray near power source.

  **WARNING** Use of electric pressure washer could create puddles and slippery surfaces. Risk of kickback. Spray gun could kickback causing you to fall resulting in death or serious injury.

- Operate the electric pressure washer from a stable surface.
- Do not overreach or stand on unstable support. Keep good footing and balance at all times.
- The cleaning area should have adequate slopes and drainage to reduce the possibility of a fall due to slippery surfaces.
- Be extremely careful if you must use the electric pressure washer from a ladder, scaffolding, or any other similar location.
- Firmly grasp spray gun with both hands when using power spray modes to avoid injury when spray gun kicks back.

  **WARNING** Risk of eye or bodily injury. Spray could splash back, propel objects or cause internal harm resulting in serious injury.

- Always wear indirect vented (chemical splash) safety goggles marked to comply with ANSI Z87.1 when using or in vicinity of this equipment. NEVER substitute safety glasses or dry-condition goggles for indirect vented safety goggles.
- Know how to stop the pressure washer and bleed pressure quickly. Be thoroughly familiar with the controls.
- DO NOT allow CHILDREN to operate the electric pressure washer.
- Keep operating area clear of all persons.
- Inspect high pressure hose before each use. NEVER repair high pressure hose; replace it.
- DO NOT repair leaking connections with sealant of any kind; replace o-rings and gaskets.
- Keep hose connected to electric pressure washer and spray gun while system is pressurized.
- ALWAYS point spray gun in safe direction while system is pressurized and squeeze spray gun trigger to release high pressure, every time you turn off the pressure washer.
- DO NOT aim spray gun at people or animals.
- DO NOT drink from hose connected accessories.
- DO NOT secure spray gun in open position.
- DO NOT leave spray gun unattended while the electric pressure washer is in ON (I) position.
- DO NOT use a spray gun which does not have a trigger lock or trigger guard in place and in working order.
- Always be certain spray gun and accessories are correctly attached.
- Stay alert – watch what you are doing.
- DO NOT operate the product when fatigued or under the influence of alcohol or drugs.
- Close supervision is necessary when this product is used near children.

 **WARNING** The high pressure stream of water that this equipment produces could cut through skin and its underlying tissues, resulting in serious injury and possible amputation.



- Spray gun traps high water pressure, even when motor is stopped and water is disconnected, which could result in serious injury.
- NEVER aim spray gun at people, animals, or plants.
  - ALWAYS point spray gun in safe direction, squeeze spray gun trigger to release high pressure, every time you turn off pressure washer.

 **WARNING** Risk of fire. Spraying flammable liquids could result in death or serious injury.

- DO NOT spray flammable liquids.

 **WARNING** Risk of fire. Overheated cord could result in death or serious injury.

- Uncoil cord completely prior to use.
- DO NOT cover cord with any material.

  **WARNING** Chemical Burn Hazard. Chemicals could cause burns resulting in death or serious injury.

- Always wear indirect vented (chemical splash) safety goggles marked to comply with ANSI Z87.1 when using chemicals.
- DO NOT substitute safety glasses or dry-condition goggles for indirect vented safety goggles.
- DO NOT use caustic liquid with electric pressure washer.
- Use ONLY pressure washer safe detergents/soaps. Follow all manufacturers instructions.

 **WARNING** This product contains lead and lead compounds, known to the state of California to cause birth defects or other reproductive harm. Wash your hands after handling this product. Cancer and Reproductive Harm - [www.P65Warnings.ca.gov](http://www.P65Warnings.ca.gov).

**NOTICE** High pressure spray could damage fragile items including glass.

- NEVER aim spray gun at plants.

**NOTICE** You must protect your unit from freezing temperatures.

- Failure to do so will permanently damage your pump and render your unit inoperable.
- Freeze damage is not covered under warranty.

**NOTICE** Improper treatment of electric pressure washer could damage it and shorten its life.

- If you have questions about intended use, ask dealer or contact authorized service center.
- DO NOT operate units with broken or missing parts, or without protective housing or covers.
- DO NOT by-pass any safety device on the electric pressure washer.
- DO NOT modify the electric pressure washer in any way.
- DO NOT move the electric pressure washer by pulling on hoses. Move unit using the transport handle supplied.
- Use ONLY branded accessories intended for use with this product.

# Assembly



**Read entire operator's manual before you attempt to assemble or operate your new electric pressure washer.**

Your electric pressure washer requires some assembly but is quickly ready for use. If you have any problems with the assembly of your electric pressure washer, please call the electric pressure washer helpline at **1-855-566-9776**. If calling for assistance, please have the model, revision, and serial number from the identification label available.

## Unpack Electric Pressure Washer

1. Remove everything from carton.
2. Raise handle (A) to upright position by pulling up latch (B) on each side of handle. Push latches down to secure handle in place.

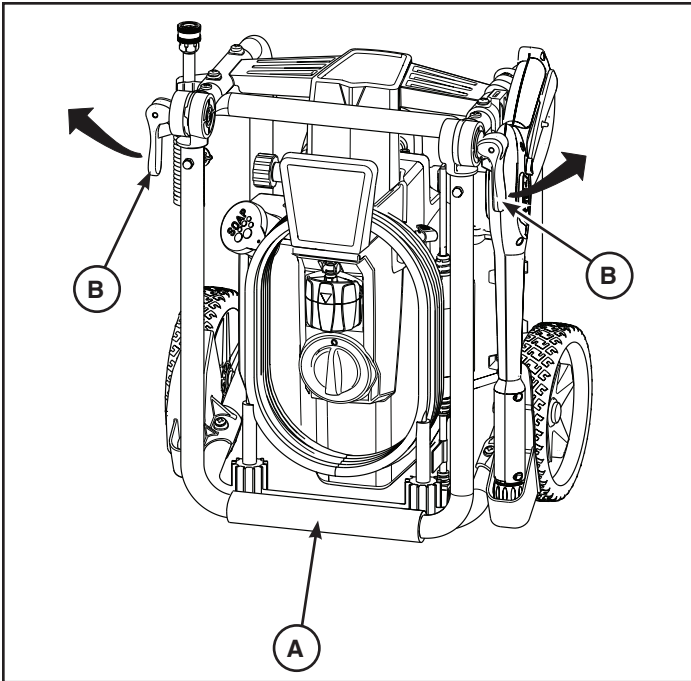

**NOTICE** The unit is equipped with a foldable handle. The handle can be folded down for storage. See *Final Storage Procedures*.

3. Ensure you have all included items prior to assembly.

## Items Included in the Carton

- Main unit
- Operator's Manual
- Spray gun
- High pressure hose
- Spray wand with nozzle holder
- Turbo nozzle
- 7-in-1 nozzle
- High pressure nozzle

Check all contents. If any parts are missing or damaged, call the electric pressure washer helpline at **(1-855-566-9776)**. Become familiar with each component before assembling the electric pressure washer. Identify contents with the illustration shown in *Features and Controls*.

## Lubricate O-rings

Lubricate all connections shown to extend the life of the o-rings.

1. Inspect and clean connecting surfaces prior to lubrication and assembly. Replace o-rings that are damaged or missing. See *Common Service Parts*.

**NOTICE** ALWAYS apply a small amount of lubricant on o-rings prior to assembling the garden hose to the pump (C), high pressure hose (D), spray gun (E) and spray wand (F).

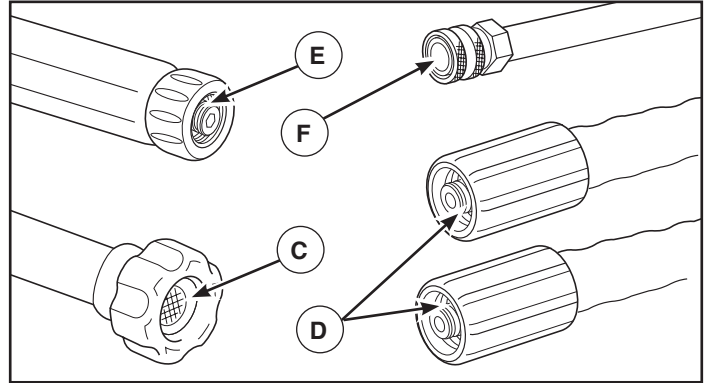

**NOTICE** Never repair leaking connections with sealant of any kind. Replace o-ring.

2. Use a small brush or cotton swab to apply a light coating of grease directly to o-rings.

## Connect Hose and Water Supply to Pump

**NOTICE** DO NOT run the pump without the water supply connected and turned on.

- Damage to equipment resulting from failure to follow this instruction will void warranty.
1. Uncoil high pressure hose (G) and attach black end of hose to base of spray gun (H). Tighten by hand.

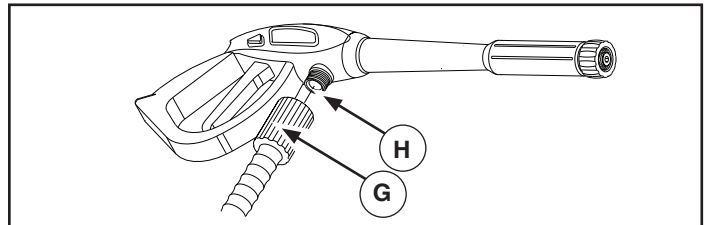

**⚠ WARNING** The high pressure stream of water that this equipment produces could cut through skin and its underlying tissues, resulting in serious injury and possible amputation.

- NEVER connect high pressure hose to spray wand.
- Keep high pressure hose connected to pump and spray gun while system is pressurized.
- Always be certain spray gun, nozzles and accessories are correctly attached.

2. Attach red end of high pressure hose (A) to high pressure outlet (B) on pump. Tighten by hand.

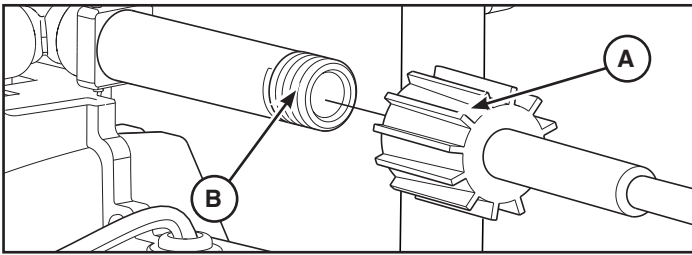

3. Run water through your garden hose for 30 seconds to clean out any debris.

**NOTICE** DO NOT siphon standing water for the water supply. Use ONLY cold water (less than 100°F (38°C)).

4. Before connecting garden hose (C) to water inlet (D), inspect inlet screen (E). Clean screen if it contains debris or have it replaced if damaged. DO NOT run pressure washer if inlet screen is damaged.

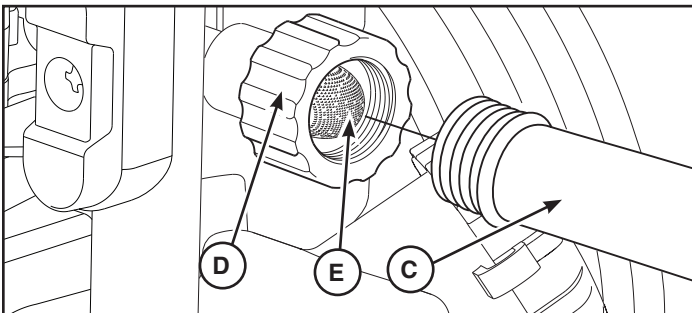

**NOTICE** Using a One Way Valve (vacuum breaker or check valve) at pump inlet could cause pump or inlet connector damage.

- There MUST be at least 10 ft. (3 m) of unrestricted garden hose between the pressure washer inlet and any device, such as a vacuum breaker or check valve.
  - Damage to equipment resulting from failure to follow this instruction will void warranty.
5. Connect the garden hose (C) (not to exceed 50 ft. (15 m) in length) to the water inlet (D). Tighten by hand.

**WARNING** Risk of eye injury. Spray could splash back or propel objects resulting in serious injury.



- Always wear indirect vented (chemical splash) safety goggles marked to comply with ANSI Z87.1 when using or in vicinity of this equipment.
- NEVER substitute safety glasses or dry-condition goggles for indirect vented safety goggles.

## Connect Spray Wand and 7-in-1 Nozzle

1. Turn ON the water, press red button (F) on the gun and squeeze the trigger to purge the pump system of air and impurities.

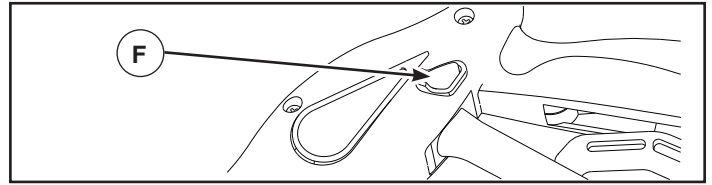

2. Place quick connect turbo and high pressure nozzle in slots on holder attached to spray wand.

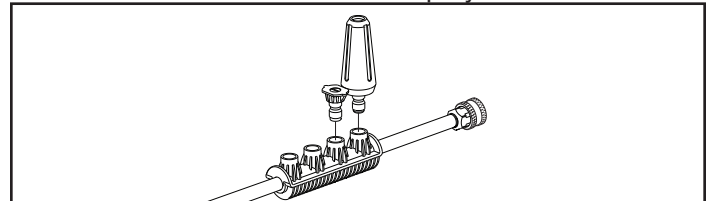

3. Attach spray wand to spray gun. Tighten by hand.

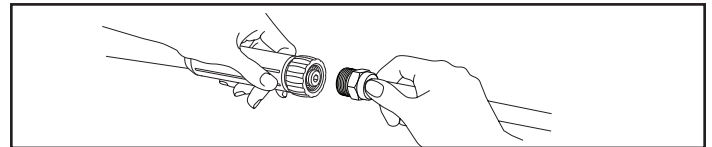

4. Choose nozzle you want to use, pull back on collar of spray wand, insert nozzle and release collar. Tug on nozzle to make sure it is securely in place. See *How to Use Nozzles*.

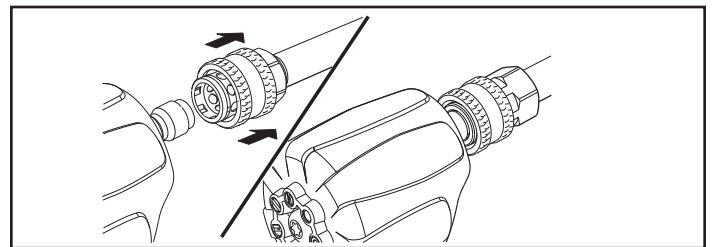

## Checklist Before Starting Pump Motor

Review the unit's assembly to ensure you have performed all of the following.

1. Be sure to read *Operator Safety and Operation* before using the electric pressure washer.
2. Check for properly tightened hose connections.
3. Check to make sure there are no kinks, cuts, or damage to hoses.
4. Provide a proper water supply at an adequate flow.
5. Plug electrical power cord into a dedicated electrical circuit rated for 120 Volts AC at 15 Amps that is properly installed in accordance with all local codes and ordinances. Check that circuit is not used to supply any other electrical needs.

## Features and Controls



**Read the Operator's Manual and safety rules before operating your electric pressure washer.**

Compare the illustrations with your electric pressure washer to familiarize yourself with the locations of various controls and adjustments. Save this original manual for future reference.

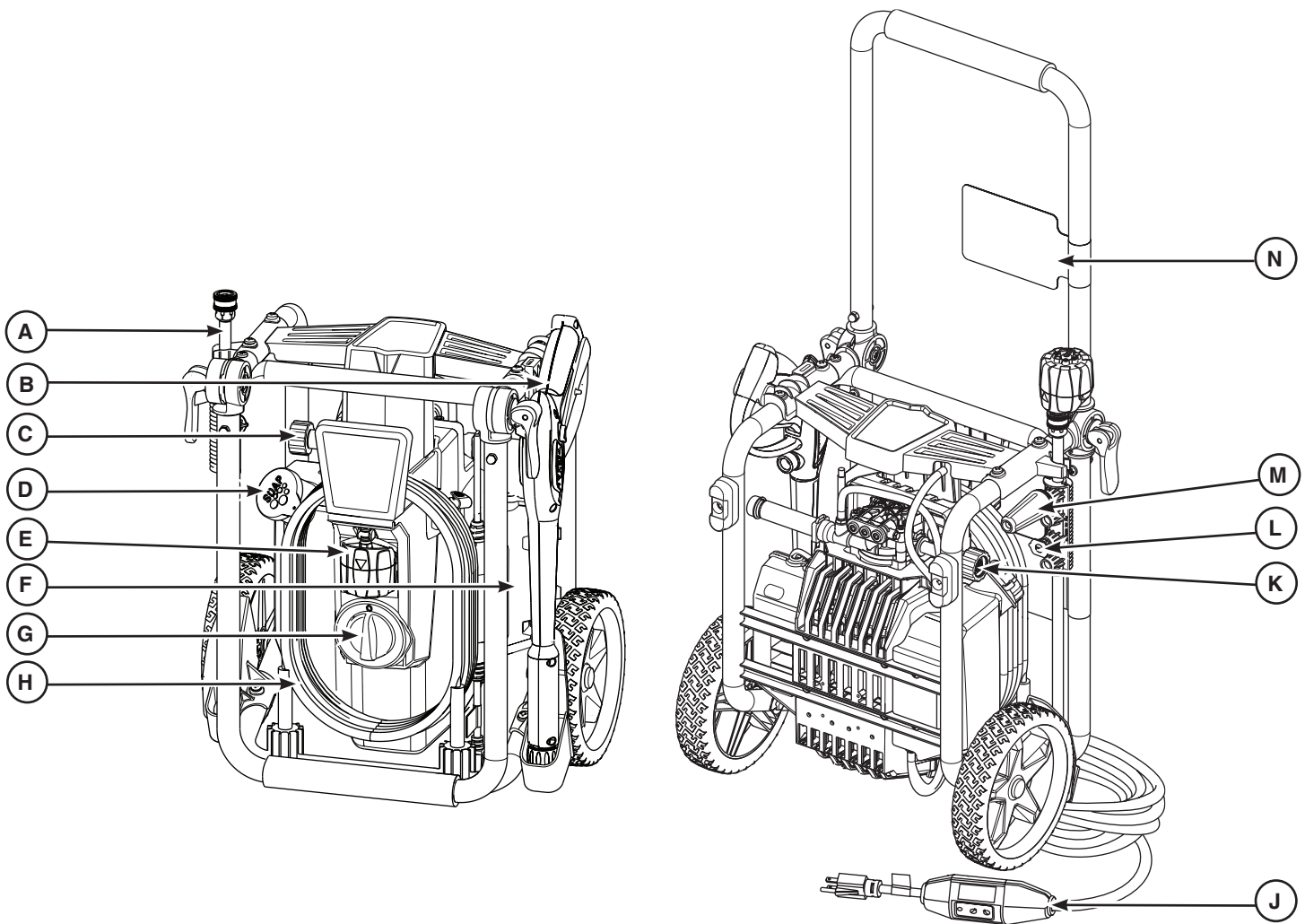

**A - Spray Wand** — Allows you to switch between different nozzles.

**B - Spray Gun** — Controls the application of water onto cleaning surface with trigger device. Includes trigger lock.

**C - Water Supply Inlet** — Connect to water supply using a 50 ft. (15.24 m) maximum garden hose.

**D - Detergent Tank** — Use to hold up to 40 fl. oz. (1.2 l) of pressure washer safe detergent.

**E - 7-in-1 Nozzle** — Contains seven different spray pattern nozzles for various applications.

**F - Identification Label** — Provides model and serial number of pressure washer. Please have these readily available if calling for assistance.

**G - Master ON/OFF Switch** — Turn switch to ON (I) position to start pressure washer. Turn switch to OFF (O) position to stop pressure washer.

**H - High Pressure Hose** — Connect red end to high pressure water outlet and black end to spray gun.

**J - Electric Cord with GFCI** — The electric pressure washer and operator is protected by a ground fault circuit interrupter (GFCI).

**K - High Pressure Outlet** — Connection for high pressure hose.

**L - High Pressure Nozzle** — Gives you the most cleaning power by producing the highest pressure.

**M - Turbo Nozzle** — Whirls a powerful pin-point jet of water for intense cleaning.

**N - Warning Label** — Identifies hazards to be avoided when using your pressure washer.



# Operation

## How to Start Your Electric Pressure Washer

Follow the instructions below in the order presented. If you have any problems operating your electric pressure washer, please call the electric pressure washer helpline at 1-855-566-9776.

**⚠ WARNING** Risk of eye injury. Spray could splash back or propel objects resulting in serious injury. Always wear indirect vented (chemical splash) safety goggles marked to comply with ANSI Z87.1 when using or in vicinity of this equipment. NEVER substitute safety glasses or dry-condition goggles for indirect vented safety goggles.

1. Place pressure washer near an outside water source capable of supplying water at a flow rate greater than 3.0 gallons (11.4 l) per minute and no less than 20 PSI (1.3 BAR) at pressure washer end of garden hose. DO NOT siphon supply water.
2. Check that high pressure hose is tightly connected to spray gun and high pressure outlet. See *Assembly* section.
3. Connect garden hose to water inlet.

**NOTICE** DO NOT run the pump without the water supply connected and turned on.

- Damage to equipment resulting from failure to follow this instruction will void warranty.
4. Turn ON water, point gun in a safe direction, press trigger lock button and squeeze trigger to purge pump system of air.
  5. Install spray wand and selected nozzle onto spray gun. See *Assembly* section.

**NOTICE** The unit can be operated in vertical or horizontal positions.

6. Turn master ON/OFF switch (A) to OFF (0) position.

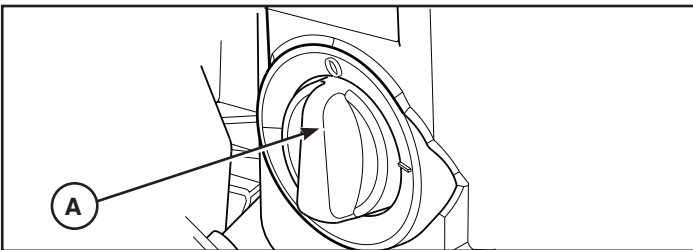

**⚠ WARNING** Risk of electrocution. Use of an extension cord could cause electric shock or burn resulting in death or serious injury.

- DO NOT use an extension cord with this electric pressure washer. Your home's electrical circuit receptacle or extension cord may not provide lifesaving ground-fault circuit-interruption protection.

7. Plug electrical power cord into a dedicated electrical circuit rated for 120 Volts AC at 15 Amps that is properly installed in accordance with all local codes and ordinances. Circuit is not to supply any other electrical needs. The indicator light on the GFCI should be ON.

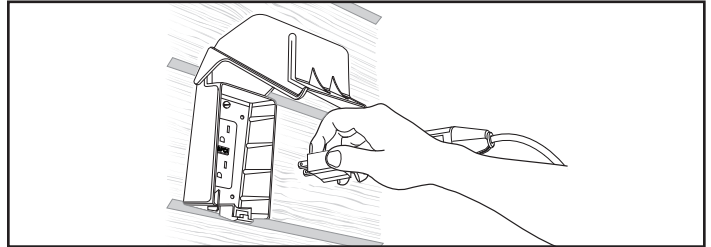

**NOTICE** The indicator light must be ON for the electric pressure washer to operate.

**⚠ WARNING** Risk of electrocution. Non-operating ground fault circuit interrupter (GFCI) could result in death or bodily injury. If indicator light does not stay ON after test and reset, do not use GFCI.

8. Press TEST button (B). The indicator light (C) should be OFF.

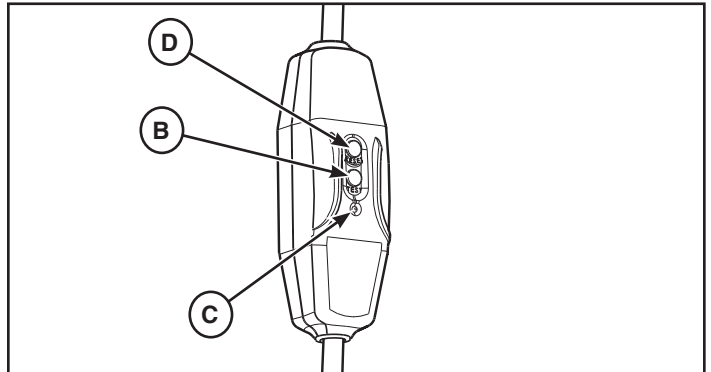

9. Press RESET button (D). The indicator light (C) should be ON.

**NOTICE** DO NOT use the electric pressure washer if above test fails.

10. Turn master ON/OFF switch to ON (I) position.
11. Point gun in a safe direction, press trigger lock button and squeeze trigger.

The electric pressure washer motor will start and stop as spray gun trigger is depressed and released.

The electric pressure washer is now ready for use.

Instructions for use of the supplied accessories are given later in this section.

## How to Stop Your Electric Pressure Washer

The electric pressure washer motor runs only when the trigger is engaged. To stop the electric pressure washer and turn off the motor:

1. Release spray gun trigger.
2. Turn master ON/OFF switch to OFF (0) position.

**NOTICE** Releasing the trigger will shut off the motor but does not shut off electrical power to the unit.

3. Turn off water supply.
4. ALWAYS point spray gun in a safe direction, press trigger lock button and squeeze trigger to relieve built up pressure in the unit.

 **WARNING** The high pressure stream of water that this equipment produces could cut through skin and its underlying tissues, resulting in serious injury and possible amputation. Spray gun traps high water pressure, even when motor is stopped and water is disconnected, which could result in serious injury.

- Keep high pressure hose connected to pump and spray gun while system is pressurized.
- ALWAYS point spray gun in safe direction, squeeze spray gun trigger to release high pressure, every time you turn off pressure washer.

5. Disconnect GFCI plug from outlet.

## How to Use Nozzles

### 7-in-1 Nozzle

The 7-in-1 nozzle allows you to switch between seven different spray pattern nozzles. Release trigger on spray gun to engage safety lock before changing spray patterns. The spray patterns vary as shown below.

1. Select desired spray pattern:

#### High Pressure:

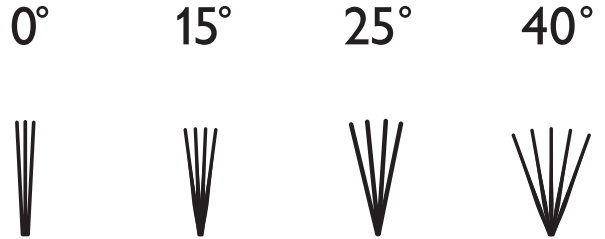

#### Low Pressure:

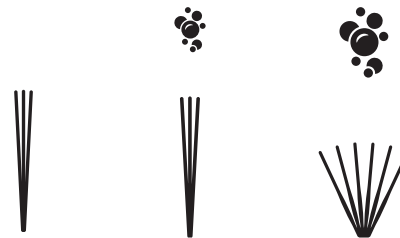

2. Turn dial until desired spray pattern lines up with arrow on 7-in-1 nozzle.

### Turbo Nozzle

The turbo nozzle whirls a powerful pin-point jet of water for intense cleaning.

#### High Pressure Nozzle

The high pressure nozzle gives you the most cleaning power by producing the highest pressure.

 **WARNING** The high pressure stream of water that this equipment produces could cut through skin and its underlying tissues, resulting in serious injury and possible amputation.

- NEVER exchange nozzles without the trigger lock being engaged on the spray gun.
- DO NOT twist nozzles while spraying.

#### Usage Tips

- For most effective cleaning, keep nozzle from 8 to 24 inches away from cleaning surface.
- If you get too close, especially using a high pressure spray pattern nozzle, you may damage surface being cleaned.
- Do Not get closer than 6 inches (15 cm) when cleaning tires.

## Applying Detergent

**⚠ WARNING** Chemical Burn Hazard.  
Chemicals could cause burns resulting in death or serious injury.

- Always wear indirect vented (chemical splash) safety goggles marked to comply with ANSI Z87.1 when using chemicals.
- DO NOT substitute safety glasses or dry-condition goggles for indirect vented safety goggles.
- DO NOT use caustic liquid with electric pressure washer.
- Use ONLY pressure washer safe detergents/soaps. Follow all manufacturers instructions.

### To apply detergent, follow these steps:

1. Review use of nozzles shown in *How to Use Nozzles*.
2. Prepare your detergent solution as required by job to be performed.
3. Remove cap from detergent tank and fill with detergent solution. Replace cap.

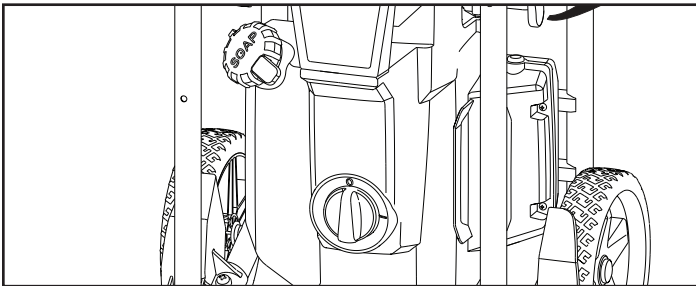

4. Make sure one of the soap spray pattern nozzles is selected on 7-in-1 nozzle.

**NOTICE** Detergent cannot be applied with non soap nozzle settings on 7-in-1 nozzle or the high pressure nozzles (turbo or high pressure).

5. Make sure garden hose is connected to water inlet and high pressure hose is connected to spray gun and high pressure outlet. Turn on water.
6. Start the pressure washer as instructed in *How to Start Your Electric Pressure Washer*.
7. Apply detergent to a dry surface, starting at lower portion of area to be washed and work upward using long, even, overlapping strokes.
8. Allow detergent to “soak in” for 3-5 minutes before washing and rinsing. Reapply as needed to prevent surface from drying. To prevent streaking, Do Not allow detergent to dry on surface.

## Electric Pressure Washer Rinsing

1. Select desired high pressure nozzle following instructions *How to Use Nozzles*.
2. Keep spray gun a safe distance from area you plan to spray.

**⚠ WARNING** Risk of kickback. Spray gun could kickback causing you to fall resulting in death or serious injury.

- Operate the electric pressure washer from a stable surface.
- Be extremely careful if you must use the electric pressure washer from a ladder, scaffolding, or any other similar location.
- Firmly grasp spray gun with both hands when using power spray modes to avoid injury when spray gun kicks back.

3. Apply a high pressure spray to a small area and then check surface for damage. If no damage is found, you can assume it is okay to continue rinsing.
4. Start at top of area to be rinsed, working down with same overlapping strokes as you used for cleaning.

### Other Cleaning Tips

- NEVER leave the electric pressure washer unattended while it is plugged into an electrical outlet and while water is supplied to the equipment.
- If you have the nozzle too far away from the surface being washed, the cleaning may not be as effective.

### How to Store Accessories

The unit is equipped with areas to store your high pressure hose, spray gun, spray wand, 7-in-1 nozzle, and power cord. Coil power cord and high pressure hose around hook. Store spray gun in the spray gun holder. Store the spray wand in the spray wand holder. The 7-in-1 nozzle can also be stored on end of spray wand. Store high pressure and turbo nozzles in holder provided on the spray wand. Identify all accessories with the illustrations in *Features and Controls*.

# Maintenance

## General Recommendations

Regular maintenance will improve the performance and extend the life of the electric pressure washer.

The electric pressure washer's warranty does not cover items that have been subjected to operator abuse or negligence. To receive full value from the warranty, the operator must maintain the electric pressure washer as instructed in this manual, including proper storage.

**NOTICE** Should you have questions about replacing components on your electric pressure washer, please call 1-855-566-9776 for assistance.

## Before Each Use

1. Clean debris.
2. Check water inlet screen for debris or damage.
3. Check high pressure hose for leaks.
4. Check spray gun operation.

## Electric Pressure Washer Maintenance

### Clean Debris

Daily or before use, clean accumulated debris from electric pressure washer. Inspect cooling air slots and openings on the front, rear and bottom of the electric pressure washer. These openings must be kept clean and unobstructed.

The electric pressure washer parts should be kept clean to reduce the risk of overheating and ignition of accumulated debris.

- Use a damp cloth to wipe exterior surfaces clean.

**NOTICE** Improper treatment of the electric pressure washer can damage it and/or shorten its life.

- DO NOT insert any objects through cooling slots.

### Check and Clean Water Inlet Screen

Examine the screen on the unit's water inlet. Clean it if the screen is clogged or replace it if screen is damaged.

### Check High Pressure Hose

The high pressure hose can develop leaks from wear, kinking, or abuse. Inspect the hose each time before using it. Check for cuts, leaks, abrasions or bulging of cover, damage or movement of couplings. If any of these conditions exist, replace the hose immediately.

**WARNING** The high pressure stream of water that this equipment produces could cut through skin and its underlying tissues, resulting in serious injury and possible amputation.

- NEVER repair high pressure hose. Replace it.
- Replacement hose rating MUST equal or exceed maximum pressure rating of unit.

## Check Spray Gun

Examine hose connection to spray gun and make sure it is secure. Test trigger (A) by pressing trigger lock button (B) and making sure trigger "springs back" into place when you release it. You should not be able to press trigger without pressing trigger lock button. Replace spray gun immediately if it fails any of these tests.

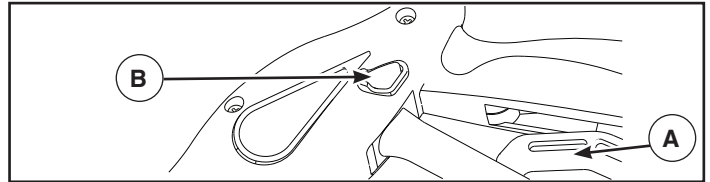

## Nozzle Maintenance

A pulsing sensation felt while squeezing the spray gun trigger may be caused by excessive pump pressure. The principal cause of excessive pump pressure is a clogged spray tip or restricted with foreign materials, such as dirt, etc. To correct the problem, immediately clean the spray tip following these instructions:

1. Turn master ON/OFF switch to OFF (0) position. Remove power cord plug from electrical outlet.
2. Disconnect water supply at the electric pressure washer.
3. ALWAYS point spray gun in a safe direction, press trigger lock button and squeeze spray gun trigger to release retained high water pressure.

**WARNING** The high pressure stream of water that this equipment produces could cut through skin and its underlying tissues, resulting in serious injury and possible amputation. Spray gun traps high water pressure, even when motor is stopped and water is disconnected, which could result in serious injury.

- Keep high pressure hose connected to pump and spray gun while system is pressurized.
- ALWAYS point spray gun in safe direction, squeeze spray gun trigger to release high pressure, every time you turn off pressure washer.

4. Remove 7-in-1 nozzle from end of spray wand.

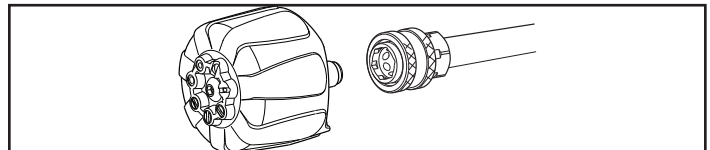

5. Use small paper clip to free any foreign material clogging or restricting any of the nozzles.
6. Remove spray wand from spray gun
7. Using a garden hose, remove additional debris by back flushing water through spray wand. Back flush between 30 to 60 seconds.

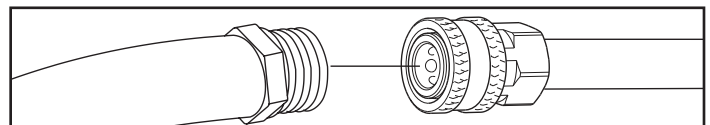

8. Reinstall 7-in-1 nozzle into spray wand.

9. Reconnect spray wand to spray gun.
10. Make sure garden hose is connected to water inlet. Check that high pressure hose is connected to spray gun and pump. Turn on water.
11. Plug power cord into electrical outlet and turn the master ON/OFF switch to the pressure washer ON (I) position.
12. Test the electric pressure washer by operating with each nozzle setting.

## Pump and Motor Maintenance

The electric pressure washer does not require any maintenance to the pump or motor. Both assemblies are pre-lubricated and sealed, requiring no additional lubrication ever.

## After Each Use

Water should not remain in the unit for long periods of time. Sediments or minerals can deposit on pump parts and “freeze” pump action. Follow these procedures after every use:

1. To ensure detergent tank does not drain during storage, run electric pressure washer with a soap setting on 7-in-1 nozzle until tank is empty.
2. Add 0.5 liter of clean fresh water to detergent tank, run electric pressure washer with a soap setting on 7-in-1 nozzle. Flush for one or two minutes.
3. Turn master ON/OFF switch to OFF (0) position. Remove power cord plug from electrical outlet.
4. Turn off water supply. Point gun in a safe direction, press trigger lock button and squeeze trigger to relieve trapped pressure.
5. Disconnect garden hose from water inlet. Disconnect high pressure hose from spray gun and high pressure outlet.
6. Drain water from hose and spray gun, then use a cloth or equivalent to wipe off all exterior surfaces.
7. Drain water from pump by tipping unit onto its right side (water inlet facing down) for two minutes. Flip unit over and let rest on high pressure outlet for an additional two minutes.
8. Coil power cord and high pressure hose around hook.
9. Store spray gun, spray wand, and 7-in-1 nozzle in provided storage areas. The 7-in-1 nozzle can also be stored on end of spray wand. Store high pressure and turbo nozzles in holder provided on the spray wand.
10. Store unit in a clean, dry area. The unit can be stored in vertical or horizontal position.
11. If storing for more than 30 days see *Winter or Long Term Storage*.

## Winter or Long Term Storage

Follow steps 1-9 in *After Each Use*.

**NOTICE** Water left in pump could freeze and permanently damage pump. Freeze damage is not covered under warranty.

## Protecting the Pump

To protect the pump from damage caused by mineral deposits or freezing, use Pump Saver™, Model 6039, to treat pump. This prevents freeze damage and lubricates plunger and seals.

**NOTICE** Pump Saver is available as an optional accessory. It is not included with the electric pressure washer. Contact the nearest authorized service center to purchase Pump Saver.

**NOTICE** You must protect your unit from freezing temperatures.

- Failure to do so will permanently damage your pump and render your unit inoperable.
- Freeze damage is not covered under warranty.

To use Pump Saver, make sure electric pressure washer is turned off and inlet and outlet hoses are disconnected. Read and follow all instructions and warnings given on the Pump Saver container.

## Final Storage Procedures

1. Coil power cord and high pressure hose around hook.
2. Store spray gun, spray wand, and 7-in-1 nozzle in provided storage areas. The 7-in-1 nozzle can also be stored on end of spray wand. Store high pressure and turbo nozzles in holder provided on the spray wand. See *Features and Controls*.
3. Store unit in a clean, dry area that is protected from freezing temperatures. The handle can be folded down for storage. The unit can be operated in vertical or horizontal positions.
4. Cover unit with a suitable protective cover that does not retain moisture.

# Troubleshooting

Problem	Cause	Correction
<b>Pump has following problems: failure to produce pressure, erratic pressure, chattering, loss of pressure, low water volume.</b>	<ol style="list-style-type: none"> <li>1. Water inlet is blocked.</li> <li>2. Inadequate water supply.</li> <li>3. Garden hose is kinked or leaking.</li> <li>4. Clogged water inlet screen.</li> <li>5. Water supply is over 100°F (38°C).</li> <li>6. High pressure hose is blocked or leaks.</li> <li>7. Nozzle is obstructed.</li> </ol>	<ol style="list-style-type: none"> <li>1. Clear inlet.</li> <li>2. Provide adequate water flow.</li> <li>3. Straighten garden hose or replace if leaking.</li> <li>4. Check and clean water inlet screen.</li> <li>5. Provide cooler water supply.</li> <li>6. Clear blocks in high pressure hose or replace hose.</li> <li>7. Clean nozzle.</li> </ol>
<b>Unit fails to start when spray gun trigger is squeezed.</b>	<ol style="list-style-type: none"> <li>1. Water supply is not turned on.</li> <li>2. Unit is not turned on.</li> <li>3. Garden hose is too long.</li> <li>4. Fuse blown or circuit breaker tripped.</li> </ol>	<ol style="list-style-type: none"> <li>1. Turn on water supply.</li> <li>2. Turn master ON/OFF switch to ON (I) position. Reset GFCI.</li> <li>3. Use only 50 ft. (15.24 m) maximum garden hose.</li> <li>4. a.) Check fuse box for blown fuse and replace as necessary or reset circuit breaker. Do not use a fuse or circuit breaker with a higher rating than that specified for your particular branch circuit. b.) Disconnect other electrical appliances and turn off lights in the circuit or operate the pressure washer on its own dedicated circuit.</li> </ol>
<b>Detergent fails to mix with spray.</b>	<ol style="list-style-type: none"> <li>1. High pressure or high flow without soap nozzle is selected.</li> <li>2. Inlet water supply pressure too high.</li> </ol>	<ol style="list-style-type: none"> <li>1. Select a high flow soap nozzle setting (indicated with bubbles).</li> <li>2. Slowly close water supply valve until chemical just starts to draw (soap suds will appear when chemical starts to draw).</li> </ol>
<b>Hose connections leaking.</b>	<ol style="list-style-type: none"> <li>1. Garden hose loose to water inlet.</li> <li>2. Loose high pressure hose connections.</li> <li>3. Damaged o-ring.</li> </ol>	<ol style="list-style-type: none"> <li>1. Hand tighten garden hose to water inlet.</li> <li>2. Remove hose completely and reinstall hand tight.</li> <li>3. Replace o-ring.</li> </ol>

**For all other issues, see an authorized dealer.**

## Specifications

Max Outlet Pressure	2,000 PSI (138 BAR)* @ 1.2 GPM (4.5 liters/min)
Max Flow Rate	1.2 GPM (4.5 liters/min)* @ 2,000 PSI (138 BAR)
Detergent Mix	See MFR's Instructions
Water Supply Temperature	Not to exceed 100°F (38°C)
Motor	Induction Type
Rated Voltage	120 Volts AC
Current	13.0 Amps

\*This pressure washer is rated in accordance to the Pressure Washer Manufacturers' Association (PWMA) standard PW101-2018 (Testing and Rating Performance of Pressure Washers).

