

FRIGIDAIRE GALLERY®

All about the

Use & Care

of your

REFURBISHED Portable Air Conditioner



Model: R-FGPC1244T1

TABLE OF CONTENTS

Important Safety Instructions	2-3	Installation Instructions	7-8
FCC Statement	4	Air Conditioner Features	9
Product Registration	5	Operating Instructions	10-12
Normal Sounds	5	Care and Cleaning	12
Unit Description	6	Before You Call	13
Accessories Included	6	Major Appliance Limited Warranty	14

Important Safety Instructions

NOTE:

This USE & CARE MANUAL provides specific operating instructions for your model. Use the Portable air conditioner only as instructed in this USE & CARE MANUAL. These instructions are not meant to cover every possible condition and situation that may occur. Common sense and caution must be practiced when installing, operating, and maintaining any appliance.

NOTE:

The power supply cord with this air conditioner contains a current detection device designed to reduce the risk of fire.

Please refer to the section 'Operation of Current Device' for details. In the event that the power supply cord is damaged, it cannot be repaired. It must be replaced with a cord from the product manufacturer.

WARNING

Avoid fire hazard or electric shock. Do not use an extension cord or an adaptor plug. Do not remove any prong from the power cord.

Grounding type wall receptacle

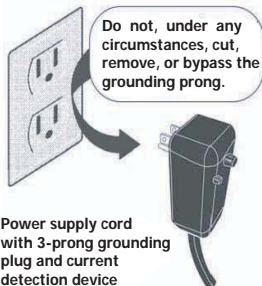

WARNING

For Your Safety

Do not store or use gasoline or other flammable vapors and liquids in the vicinity of this or any other appliance. Read product labels for flammability and other warnings.

WARNING

Prevent Accidents

To reduce the risk of fire, electrical shock, or injury to persons when using your air conditioner, follow basic precautions, including the following:

- Be sure the electrical service is adequate for the model you have chosen. This information can be found on the serial plate, which is located on the side of the cabinet.
- If the air conditioner is to be installed in a window, you will probably want to clean both sides of the glass first.
- Be sure the air conditioner has been securely and correctly installed according to the installation instructions in this manual. Save this manual for possible future use in removing or reinstalling this unit.

WARNING

Electrical Information

The complete electrical rating of your new portable air conditioner is stated on the serial plate. Refer to the rating when checking the electrical requirements.

- Be sure the air conditioner is properly grounded. To minimize shock and fire hazards, proper grounding is important. The power cord is equipped with a three-prong grounding plug for protection against shock hazards.
- Your air conditioner must be used in a properly grounded wall receptacle. If the wall receptacle you intend to use is not adequately grounded or protected by a time delay fuse or circuit breaker, have a qualified electrician install the proper receptacle.
- Do not run air conditioner without outside protective cover in place. This could result in mechanical damage within the air conditioner.
- **Do not use an extension cord or an adaptor plug.**

SAFETY PRECAUTIONS

DANGER! Avoid Serious Injury or Death

- This air conditioner contains no user-serviceable parts. Always call an authorized Electrolux servicer for repairs.
- Do not insert or place fingers or objects into the air discharge area on top of the unit.
- Do not start or stop the air conditioner by unplugging the power cord or turning off the power at the electrical box.
- Do not cut or damage the power cord.
- If the power cord is damaged, it should only be replaced by an authorized Electrolux servicer.
- In the event of a malfunction (sparks, burning smell, etc.), immediately stop the operation, disconnect the power cord, and call an authorized Electrolux servicer.
- Do not operate the air conditioner with wet hands.
- Do not pull on the power cord.
- Do not drink any water that is drained from the air conditioner.

Important Safety Instructions

SAFETY PRECAUTIONS

CAUTION! Avoid Injury or damage to the unit or other property

- Provide occasional ventilation during use. Do not direct airflow at fireplaces or other heat related sources as this could cause flare ups or make units run excessively.
- Do not climb on or place objects on the unit.
- Do not hang objects off the unit.
- Do not place containers with liquids on the unit.
- Turn off the air conditioner at the power source when it will not be used for an extended period of time.
- Periodically check the condition of the unit's installation accessories for any damage.
- Do not apply heavy pressure to the radiator fins of the unit.
- Operate the unit with air filter in place.
- Do not block or cover the intake grille, discharge area and outlet ports.
- Ensure that any electrical/electronic equipment is one yard away from the unit.
- Do not use or store flammable gases near the unit.

READ THIS SECTION BEFORE ATTEMPTING TO OPERATE AIR CONDITIONER.
Unit must be upright for one hour prior to operating.

Operation of Current Device

Plug in &
press RESET

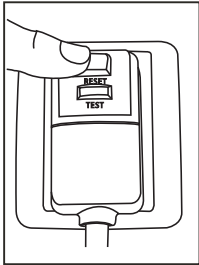

The power supply cord contains a current device that senses damage to the power cord. To test your power supply cord do the following:

1. Plug in the Air Conditioner.
2. The power supply cord will have TWO buttons on the plug head. Press the TEST button. You will notice a click as the RESET button pops out.
3. Press the RESET button. Again you will notice a click as the button engages.
4. The power supply cord is now supplying electricity to the unit. (On some model, this is also indicated by a light on the plug head)

NOTE:

- Do not use this device to turn the unit on or off.
- Always make sure the RESET button is pushed in for correct operation.
- The power supply cord must be replaced if it fails to reset when either the TEST button is pushed, or it cannot be reset. A new one can be obtained from the product manufacturer.
- If power supply cord is damaged, it CANNOT be repaired. It MUST be replaced by one obtained from the product manufacturer.

FCC Statement

FCC Interference Statement

This equipment has been tested and found to comply with the limits for a Class B digital device, pursuant to part 15 of the FCC Rules. These limits are designed to provide reasonable protection against harmful interference in a residential environment. This equipment generates, uses, and can radiate radio frequency energy and, if not installed and used in accordance with the instructions, may cause harmful interference to radio communications. However, there is no guarantee that interference will not occur in a particular installation. If this equipment does cause harmful interference to radio or television reception, which can be determined by tuning the device off and on, the user is encouraged to try to correct the interference by one or more of the following measures:

- Reorient or relocate the receiving antenna.
- Increase the separation between the device and receiver.
- Connect the equipment into an outlet other than the one used for the receiver.
- Consult the dealer or an experienced radio/TV technician for assistance.

This device complies with Part 15 of the FCC Rules. Operation is subject to the following two conditions: (1) This device may not cause harmful interference, and (2) This device must accept any interference received, including interference that may cause undesired operation.

FCC CAUTION: Any changes or modifications not expressly approved by the party responsible for compliance could void the user's authority to operate the equipment.

Host device Labeling

This device includes the following module.
Contains FCC ID: 2AIBX-WD115

RF exposure statement

This equipment complies with FCC radiation exposure limits set forth for an uncontrolled environment. This equipment should be installed and operated with minimum 20 cm between the radiator and your body. This transmitter must not be collocated or operating in conjunction with any other antenna or transmitter unless authorized to do so by the FCC.

INDUSTRY CANADA (IC) STATEMENT

This Class B digital apparatus complies with Canadian ICES-003.

This device complies with Industry Canada license-exempt RSS standard(s). Operation is subject to the following two conditions: (1) this device may not cause interference, and (2) this device must accept any interference, including interference that may cause undesired operation of the device.

Le présent appareil est conforme aux CNR d'Industrie Canada applicables aux appareils radio exempts de licence. L'exploitation est autorisée aux deux conditions suivantes : (1) l'appareil ne doit pas produire de brouillage, et (2) l'utilisateur de l'appareil doit accepter tout brouillage radioélectrique subi, même si le brouillage est susceptible d'en compromettre le fonctionnement.

RF Exposure

The antenna (or antennas) must be installed so as to maintain at all times a distance minimum of at least 20 cm between the radiation source (antenna) and any individual. This device may not be installed or used in conjunction with any other antenna or transmitter.

l'exposition aux RF

L'antenne (ou les antennes) doit être installée de façon à maintenir à tout instant une distance minimum de au moins 20 cm entre la source de radiation (l'antenne) et toute personne physique.

Host device Labeling

This device includes the following module.
Contains IC: 21700-NIUX

Host dispositif d'étiquetage

Ce dispositif inclut le module suivant.
Contient module émetteur IC: 21700-NIUX

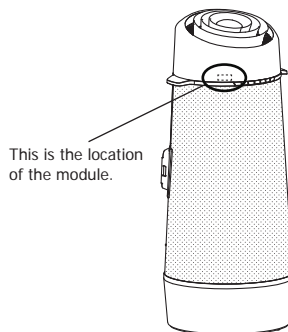

Product Registration & Normal Sounds

Product Registration

Record Your Model and Serial Numbers

Record in the space provided below the model and serial numbers. On all models, the serial plate is located on the side of the cabinet.

Model No. _____

Serial No. _____

Register Your Product

Visit www.arcaugusta.com/register-my-product.htm

Normal Sounds

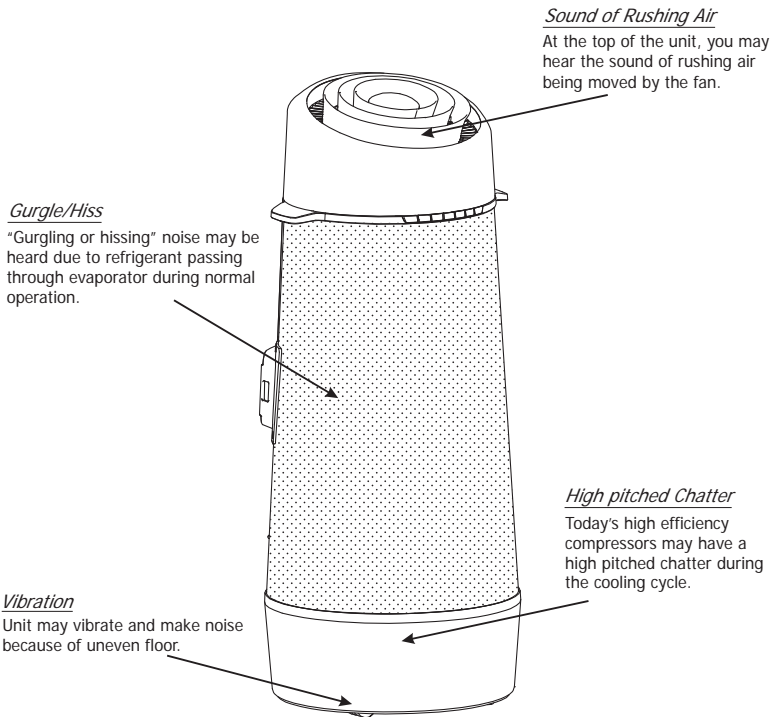

Unit Description & Accessories Included

Unit Description

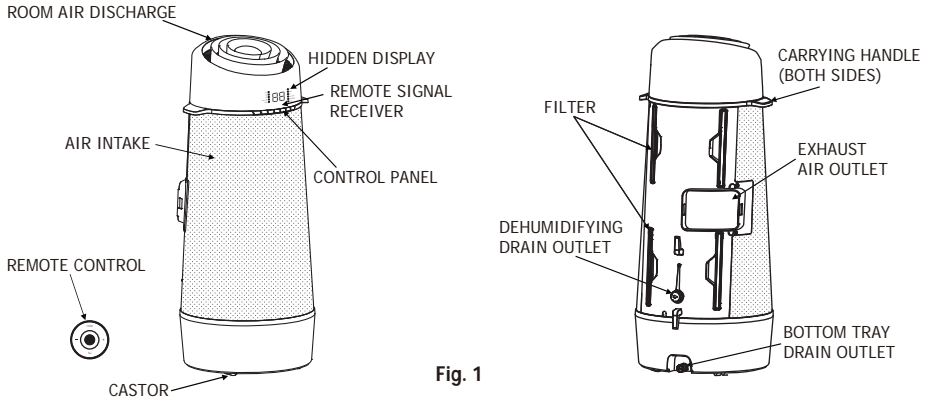

Fig. 1

Accessories Included







PARTS:	PARTS NAME:	QUANTITY:
	Exhaust hose	1 pc
	Window Sliding Kit	1 set
	Foam Seal A	2 pcs
	Foam Seal B	1 pcs
	Spared Extend Rod	1 pc
	3/8" Screw	1 pcs
	Remote Control	1 pc

Fig. 2

- Check all the accessories are included in the package and please refer to the installation instructions for their usage. **Note that refurbished models may not include all accessories.**

Installation Instructions

EXHAUSTING HOT AIR

In the COOLING Mode the appliance must be placed close to a window or opening so that the warm exhaust air can be ducted outside.

First position unit on a flat floor and make sure there's a minimum of 12" clearance around the unit, and is within the vicinity of a single circuit outlet power source. It is recommended to have a 50" clearance in the back of the unit.

1. Extend either side of the hose (Fig. 3).
2. Slide the adaptor A into the exchange hole of the unit as shown on Fig. 4.
3. Install the window kit on the window and slide the adaptor B into the window slider kit and seal. (Fig. 5 & 6)

NOTE: Refer to page 8 about how to install the window kit.

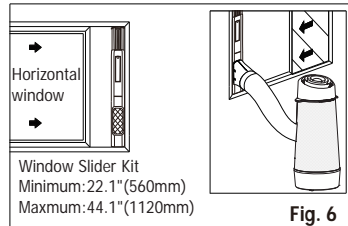
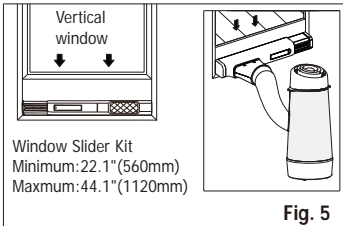
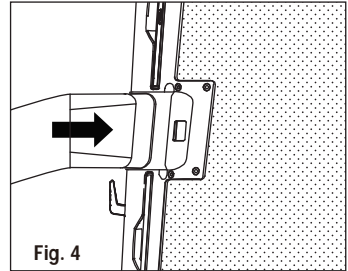
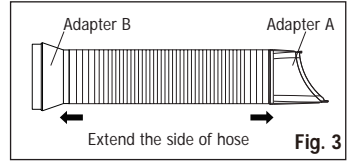

The hose can be extended from its original length of 15" up to 59", but it is the best to keep the length to minimum required. Also make sure that the hose does not have any sharp bends or sags. (Fig. 7)

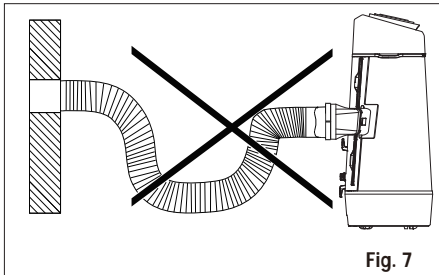

Installation Instructions

Installation Instructions (continued)

Installation in a double-hung sash/sliding sash window

1. Cut the foam seals A (adhesive type) to the proper lengths and attach them to the window and stool (Fig. 8).
2. Open the window sash and lift the locking lever of the window slider kit (Fig. 9), then place the window slider kit on the window stool. Adjust the length of the window slider kit according to the width of window (Fig. 10).

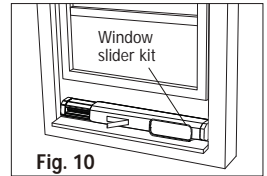
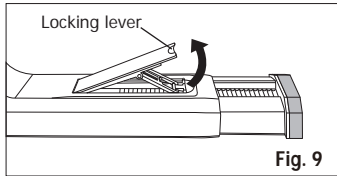
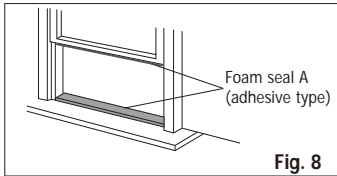

NOTE: If the window is too wide, you can replace the pre-installed telescopic rod with the spared extend rod or combine the 2 rods. The recommended usage of the rods are as below:

- With 280mm pre-installed telescopic rod only: available range=560mm-780mm
- With 350mm spared extend rod only: available range =630mm-850mm
- With the combination: available range 850mm-1120mm

To replace the pre-installed telescopic rod with the spared extend rod, first take out the telescopic rod completely(Fig.11 A). Then take down the cap from the pre-installed telescopic rod and put it on the spared extend rod.

To combine the 2 rods, first take out the telescopic rod completely(Fig.11 A). Then align the 3 hooks on the extending rod to the 3 slots on the end of the telescopic rod and slide the 3 hooks into the slots, then press down the extending rod to lock the slots(Fig.11 B). After that slide the combined telescopic rod back into the window kit(Fig.11 C).

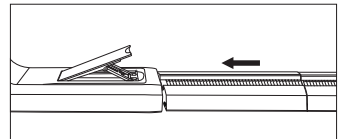
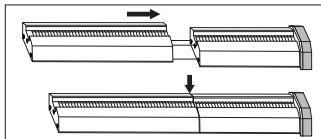
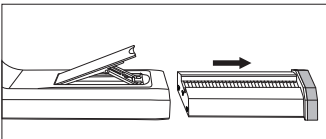

3. Press back the locking lever to fix the length of the window slider kit then close the window sash securely against the window slider kit (Fig. 12).
4. To secure lower sash, attach sash lock with 3/8" (9.5mm) screw as shown Fig. 13.

NOTE: It is difficult to lock the windows with the sash lock for Vinyl-Clad windows, so you can use lock by window itself.

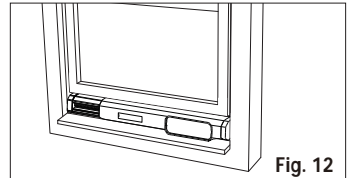

5. Cut the foam seal B(adhesive type) to an appropriate length and seal the open gap between the top window sash and outer window sash, as shown in Fig. 14.
6. Cut the decoration film to an appropriate length and stick on the extending rod channel(Fig. 15).

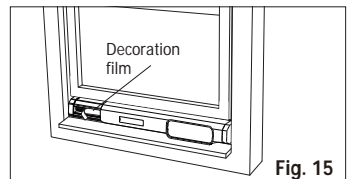
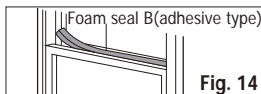
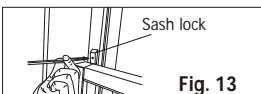

Air Conditioner Features

CONTROL PANEL

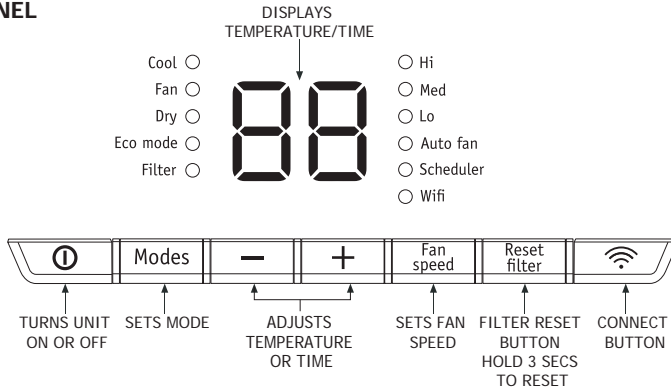

Fig. 18

NOTE: Please see Quick Start Guide for how to download the Frigidaire® - Smart Appliance APP and find out more detail about how to connect the unit and use the "Scheduler" function in the APP.

REMOTE CONTROL

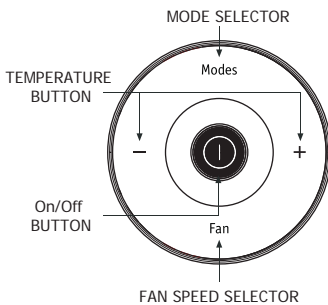

Fig. 19

Note: Open the back covers and remove the protecting film to activate the remote control, when use for the first time.

To replace the battery

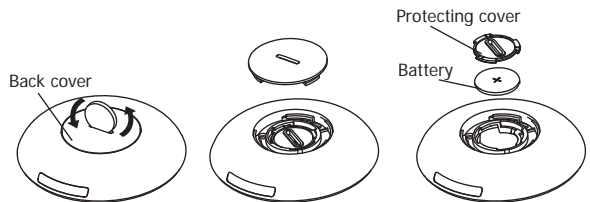

Fig. 20

Fig. 21

Fig. 22

Turn over the remote control. In the button of the remote control there is a slot. Use a coin or something like that to rotate the back cover anti-clockwise to open it.(Fig.20 & 21) Use the same way to open the protecting cover inside and take out the battery.(Fig.22) Replace the battery and reinstall the inside cover and back cover.
Note: Place battery in tray with POSITIVE(“+”) side facing UP.

Battery Type: RG15D/E-ELL (Rated Voltage:3VDC)

Warning:

1. Be sure the batteries are inserted properly.
2. Do not use batteries other than the type specified.
3. Do not use old batteries with new ones .
4. Do not dispose of batteries in fire. Batteries may explode or leak.
5. To prevent damage, remove the batteries when not being used for a long time.
6. This device complies with Part 15 of the FCC Rules. Operation is subject to the following two conditions:
 - (1) This device may not cause harmful interference, and
 - (2) this device must accept any interference received, including interference that may cause undesired operation.



WARNING: Chemical Burn Hazard. Keep batteries away from children.

This product contains a lithium button/coin cell battery. If a new or used lithium button/coin cell battery is swallowed or enters the body, it can cause severe internal burns and can lead to death in as little as 2 hours. Always completely secure the battery compartment. If the battery compartment does not close securely, stop using the product, remove the batteries, and keep it away from children. If you think batteries might have been swallowed or placed inside any part of the body, seek immediate medical attention. The cells shall be disposed of properly, including keeping them away from children; Even used cells may cause injury.

Operating Instructions

Operating Instructions

NOTE

The following instructions represent the Control Panel and some functions can only be selected by using the control panel.

COOLING MODE: In this mode the exhaust adaptor hose **MUST** be used.

1. Press the "modes" button until the "cool" indicator lights.
2. Press the "-" & "+" Temp buttons for desired setting.
3. Press the "fan speed" button for desired fan speed.

DRY MODE: In this mode you do not need to use the exhaust adaptor hose, **BUT** the water collected must be discharged. See Drainage Section.

1. Press the "modes" button until the "dry" indicator lights.
2. The fan will run at low speed and the display will show the room temperature.
3. Keep doors & windows closed for best effect.

ECO MODE: Always have the exhaust hose attached in this mode. The unit will run in energy saver(econ) mode when used for the first time. In this mode, the fan will continue to run for 3 minute after the compressor shuts off. The fan then cycles on for 90 seconds at 10 minutes intervals until the room temperature is above the set temperature, at which time the compressor turns back on.

FAN MODE: In this mode there is no need to use the exhaust hose or drainage hose. However, if you require stale or smokey air to be removed from the room, hook up the duct accessories as described in the "EXHAUSTING HOT AIR" section.

1. Press the "modes" button until the "fan" indicator lights.
2. Press the "fan speed" button to choose the desired fan speed.
3. The fan will run at the selected speed and the display will show the room temperature.

CHECK FILTER FEATURE: This feature is a reminder to clean the Air Filter (See Care and Cleaning) for more efficient operation. The filter indicator will illuminate after 250 hours of operation. To reset after cleaning the filter, press and hold the "filter" button for 3 seconds and the light will go off.

SELECTING FAN SPEED: You can select the desired fan speed, by pressing the "fan speed" button. The fan speed will change in the sequence as the drawing on the left.

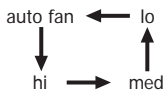

NOTE: After choosing the fan speed as "auto fan", "lo", "med" or "hi", the corresponding fan speed indicator light will illuminate. Under Dry mode, you can not select the fan speed.

DEACTIVATE WIFI MODULE: The wifi module can be deactivated by holding the "Connect button" and "-" synchronously 3 seconds. Press the "Connect button" again to activate the wifi module again. It will take about 30 seconds for the module to initiate again.

Operating Instructions (continued)

FAULT CODE:



If the display reads "AS", the room temperature sensor has failed. Contact your Authorized Frigidaire Service Center.



If the display reads "ES", the evaporator temperature sensor has failed. Contact your Authorized Frigidaire Service Center.



If the display reads "E4", the display panel communication has failed. Contact your Authorized Frigidaire Service Center.



If the display reads "P1", bottom tray is full. Carefully move the unit to a drain location, remove the bottom drain plug and let the water drain away. Restart the machine until the "P1" symbol disappears. If error repeats, call for service.



If the display reads "E7", the indoor motor has failed. Contact your Authorized Frigidaire Service Center.

DRAINAGE:

During the dry mode, you will need a garden hose (sold separately) to drain the condensate from the unit.

Remove the rubber stopper from the hose connector, then screw on a garden hose to the connector as shown on Fig. 23.

The hose may then:

- A. Discharge into a drain that is lower than the unit.
- B. Be connected to a condensate pump (sold separately).
- C. During cooling mode, please replace the rubber stopper to the hose connector to reach the maximum performance.

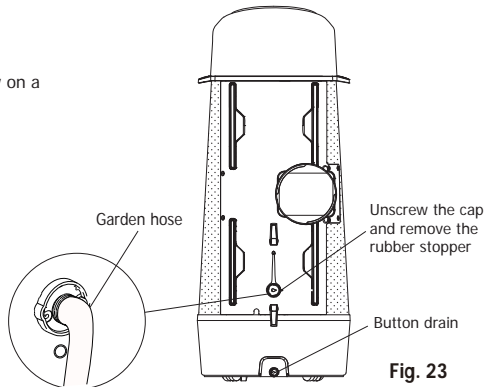

Fig. 23

Operating Instructions, CARE & CLEANING

Operating Instructions (continued)

ADDITIONAL THINGS YOU SHOULD KNOW

Now that you have mastered the operating procedure, here are more features in your control that you should become familiar with.

- The "Cool" circuit has an automatic 3 minutes time delayed start if the unit is turned off and on quickly. This prevents overheating of the compressor and possible circuit breaker tripping. The fan will continue to run during this time.
- Temperature can be set between 60 °F and 90 °F (16 °C and 32 °C).
- The control is capable of displaying temperature in degrees Fahrenheit or degrees Celsius. To convert from one to the other and back, press and hold the "TEMP" Up (+) and Down (-) buttons together for 3 seconds.
- There is a 2-Second delay for the compressor shutting down when selecting FAN ONLY. This is to cover the possibility of having to roll through to select another mode.
- After a power outage, the unit will memorize the last setting and return the unit to the same setting once power is restored.
- Indoor operating temperature range for this product is 60 °F to 95 °F (16 °C to 35 °C).
- Wifi module can be shut down by holding the "wifi" button and "-" button simultaneously for 3 seconds.
- During normal operation, the unit's display will show room temperature but when the room temperature is over 99 °F (37 °C) the display will show "HI".
- After 60 seconds of control inactivity the display and indicator lights will turn off. Press any button on the control panel or remote control and the display will resume.
- This unit have a anion generator which can be turn on/off by using the "Clean air" feature in the APP. When this feature is "ON", the electronic air purifier is energized to remove pollen and impurities from the air. (This feature can be activated on the APP ONLY)

CARE & CLEANING

Clean your air conditioner occasionally to keep it looking new. **Be sure to unplug the unit before cleaning to prevent shock or fire hazards.**

Air Filter Cleaning

- This unit has four filters, they are located on the back of the unit. Grasp the filters tab and pull off the filters one by one(Fig.24).
- Wash the filter using liquid dishwashing detergent and warm water. Rinse filter thoroughly. Gently shake excess water from the filter. Be sure filter is thoroughly dry before replacing.
- Or, instead of washing you may vacuum the filter clean.
- Replace the filter after the filter is dry.

Cabinet Cleaning

- Be sure to unplug the air conditioner to prevent shock or fire hazard. The cabinet and front may be dusted with an oil-free cloth or washed with a cloth dampened in a solution of warm water and mild liquid dishwashing detergent. Rinse thoroughly and wipe dry.
- Never use harsh cleaners, wax or polish on the cabinet front.
- Be sure to wring excess water from the cloth before wiping around the controls. Excess water in or around the controls may cause damage to the air conditioner.

Winter Storage

If you plan to store the appliance during the winter, cover it with plastic or return it to its carton.

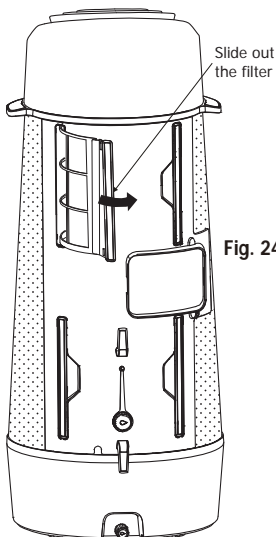

Before calling for service, review this list. It may save you time and expense. This list includes common occurrences that are not the result of defective workmanship or materials in this appliance.

OCCURRENCE	SOLUTION
Air conditioner will not operate.	<p>Wall plug disconnected. Push plug firmly into wall outlet.</p> <p>Plug Current Device Tripped. Press the RESET button.</p> <p>House fuse blown or circuit breaker tripped. Replace fuse with time delay type or reset circuit breaker.</p> <p>Control is OFF. Turn Control ON and set to desired setting.</p> <p>P1 appears in the display window. Drain water as described in Drainage Section.</p> <p>Room Temperature lower than the set temperature (Cool Mode). Reset the temperature.</p>
Air from unit does not feel cold enough.	<p>Room temperature below 60 °F (16 °C). Cooling may not occur until room temperature rises above 60 °F (16 °C).</p> <p>Reset to a lower temperature.</p> <p>Compressor shut-off by changing modes. Wait approximately 3 minutes and listen for compressor to restart when set in the COOL mode.</p>
Air conditioner cooling, but room is too warm - ice forming on cooling coil behind decorative front	<p>Outdoor temperature below 60 °F (16 °C). To defrost the coil, set FAN ONLY mode.</p> <p>Air filter may be dirty. Clean filter. Refer to Care and Cleaning section. To defrost, set to FAN ONLY mode.</p> <p>Temperature is set too low for night-time cooling. To defrost the coil, set to FAN ONLY mode. Then, set temperature to a higher setting.</p> <p>Exhaust duct not connected or blocked. See EXHAUSTING HOT AIR Section.</p>
Air conditioner cooling, but room is too warm - NO ice forming on cooling coil behind decorative front.	<p>Dirty air filter - air restricted. Clean air filter. Refer to Care and Cleaning section.</p> <p>Temperature is set too high. Set temperature to a lower setting.</p> <p>Air directional louvers positioned improperly. Position louvers for better air distribution.</p> <p>Front of unit is blocked by drapes, blinds, furniture, etc. - restricts air distribution. Clear blockage in front of unit.</p> <p>Doors, windows, registers, etc. open - cool air escapes. Close doors, windows, registers, etc.</p> <p>Unit recently turned on in hot room. Allow additional time to remove "stored heat" from walls, ceiling, floor and furniture.</p>
Air conditioner turns on and off rapidly.	<p>Dirty air filter - air restricted. Clean air filter.</p> <p>Outside temperature extremely hot. Set FAN speed to a faster setting to bring air through cooling coils more frequently.</p>
Noise when unit is cooling.	<p>Air movement sound. This is normal. If too loud, set to lower FAN setting.</p> <p>Vibraion from uneven floor. Move or support appliance correctly on even surface.</p>
Room too cold.	<p>Set temperature too low. Increase set temperature.</p>
Trouble connecting the smart appliance to your wifi network or experiencing an issue with the app.	<p>Please visit Frigidaire.com and select the Owner Support section to view Frequently Asked Questions.</p>

If These Solutions Fail, contact support@arcaugusta.com