

## MAINTENANCE

### Brushroll/Soft Roller Access

1. To open the brushroll garage, slide both release buttons on the floor nozzle away from you, towards the back of the nozzle, then lift off the lid.

2. To close the brushroll garage, insert the 3 tabs on top of lid into the 3 slots in the nozzle, then push down on both sides of lid until it clicks securely into place. If Brushroll Indicator Light isn't green and headlights are flashing, check again that both sides of lid are locked in place.

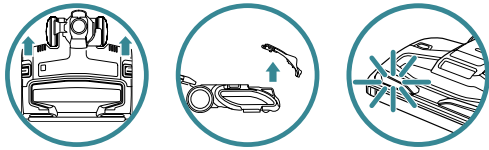

### Brushroll Maintenance

With the garage lid removed, carefully clear away any debris that may be impeding the brushroll.

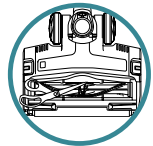

**NOTE:** If you see any hair wrapped around the brushroll, continue cleaning, using Setting II, Carpet, on bare floors. This will allow Zero-M™ technology to remove the hair wrap and send it to the dust cup.

### Empty the dust cup every time debris reaches the MAX fill line.

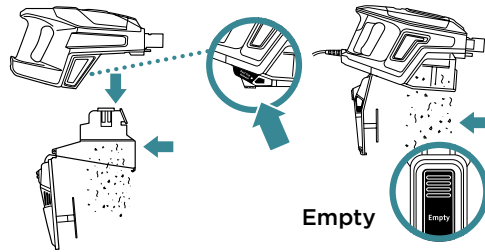

### Cleaning the Soft Roller

Lift out the Soft Roller by pulling the tab on the right side. Clear away any debris, then slide the Soft Roller back into place.

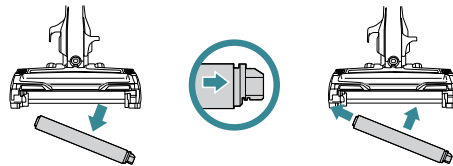

### Checking the Nozzle for Blockages

Tilt neck of nozzle back to straighten the airway, then remove any blockages.

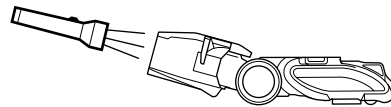

Please be sure to download the Shark® Owner's Guide prior to using your unit by visiting [www.sharkclean.com](http://www.sharkclean.com)

# Shark®

## APEX® Corded Stick Vac

### R-ZS362

## QUICK START GUIDE

Use this Quick Start Guide to start using your REFURBISHED vacuum's great features.

Register your vacuum at [arcaugusta.com/register-my-product](http://arcaugusta.com/register-my-product)

For additional parts and accessories, visit [sharkaccessories.com](http://sharkaccessories.com)

## HAVING TROUBLE?

### ISSUE

Vacuum lifts area rugs.

### Solution

Turn off the unit to disengage the brushroll and restart with the Power button.

### ISSUE

Vacuum is not picking up debris. No suction or light suction.

### Solution

Empty dust cup, clean filters, check all openings for blockages.

For questions or to register your product, visit Shark online at [sharkclean.com](http://sharkclean.com)

Refurbished by America's Remanufacturing Company, an independent company not affiliated with SharkNinja Operating LLC. This product is warranted and supported by America's Remanufacturing Company.

©2018 SharkNinja Operating LLC. APEX, DUOCLEAN and SHARK are registered trademarks of SharkNinja Operating LLC. ZERO-M is a trademark of SharkNinja Operating LLC.



@sharkcleaning

duo clean®

WITH  
ZERO-M™  
TECHNOLOGY



## WHAT'S INSIDE:

- A Handheld Vacuum
- B Motorized Floor Nozzle
- C Wand
- D 5" Crevice Tool
- E Pet Multi-Tool
- F Precision Duster

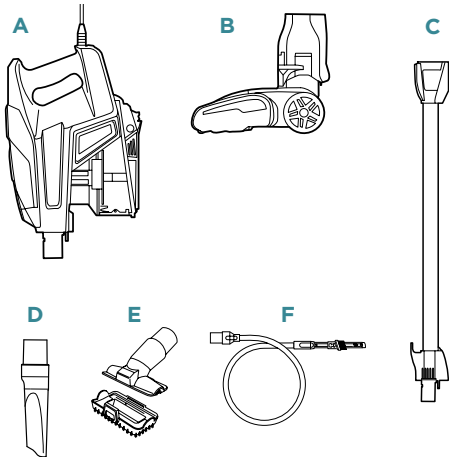

## ASSEMBLY

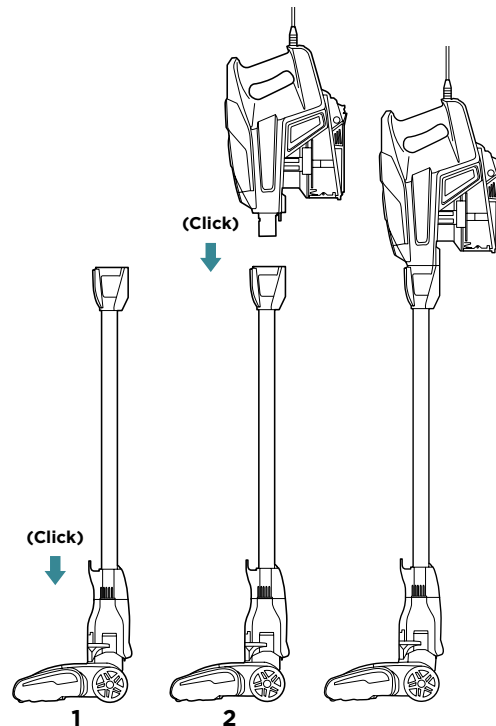

## VERSATILE FLOOR-TO-CEILING CLEANING

### UPRIGHT MODE

To clean floors, place foot on floor nozzle and tilt handheld vacuum back.

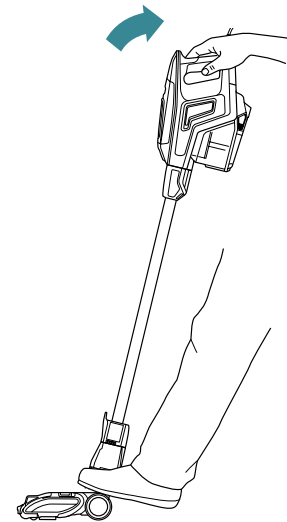

**NOTE:** All accessories are compatible with both the wand and the handheld vacuum. Use Setting I, Bare Floor/Small Area Rugs, with all above-floor accessories.

### ABOVE-FLOOR WITH WAND

Stand the vacuum upright. Step on the foot pedal on the bottom left side of the floor nozzle and pull the wand up to disconnect it. Great for cleaning baseboards, ceiling fans, window sills, etc.

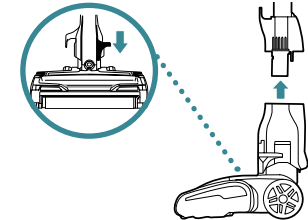

### ABOVE-FLOOR WITH HANDHELD

Press the **Wand Release** button and lift the handheld vacuum off the wand. Great for cleaning stairs and furniture.

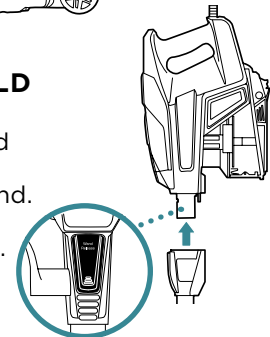

## DUOCLEAN® TECHNOLOGY

### ON FLOORS

Direct engagement with the Soft Roller removes large particles, small particles, and stuck-on dust.

#### Setting I: Bare Floor/Small Area Rugs

Gentle on bare floors and small area rugs.

The brushrolls will spin slowly to help with debris pickup.

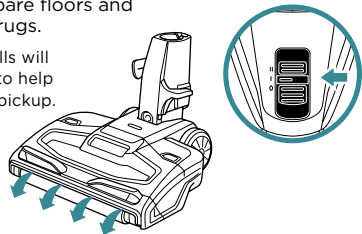

### ON CARPETS\*

The Soft Roller pulls in large particles, while the deep-cleaning brushroll removes embedded fine dirt.

#### Setting II: Carpet

Optimized brushroll speed for carpets.

The brushrolls will spin faster to help pick up debris below the surface.

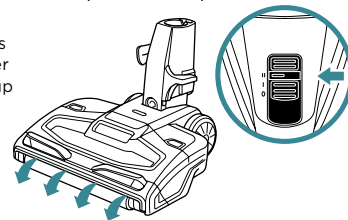

## STORAGE

### ONBOARD HOOK

Hang the handheld vacuum on the hook on the bottom of the wand, and wrap the power cord around the cord hooks.

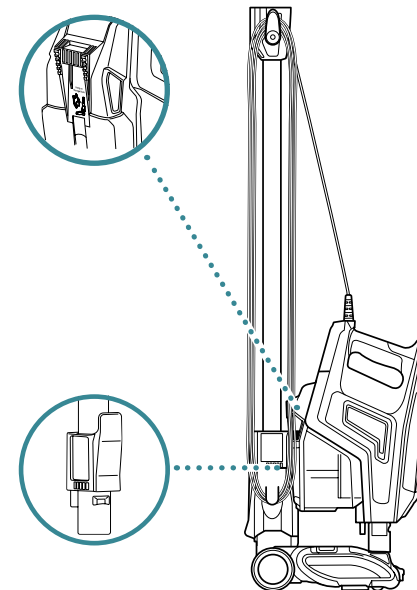

\*For deep cleaning per ASTM F 608 (embedded dirt in carpet) please use Setting II, Carpet.