

# INSTALLATION AND OPERATION INSTRUCTION FOR WINDOW-TYPE AIR CONDITIONER



Arctic   
 Wind

## ■ MODEL

---

AW5005M

AW8005E

AW6005E

AW10005E

## **Foreword**

Air conditioners are pieces of high value. In order to ensure your lawful rights and interests, please have the professional technicians do the installation for you. This Instruction Manual is the universal-purpose version for the models of window-type air conditioners manufactured by our Co. The appearance of the units that you purchase might be slightly different from the ones described in the Manual, but it does not affect your proper operations and usage. Please read carefully the sections corresponding to the specific model you choose, and keep the Manual properly so as to facilitate your reference at later time.

### **Addition to the user manual:**

The appliance is not intended for use by young children or infirm persons without supervision; Young children should be supervised to ensure that they do not play with the appliance.

## **Contents**

---

Instructions to end-users	1
Nomenclature and functions of various parts	3
Use of remote controller	5
Methods of maintenance	9
Diagnosis on phenomena and treatments	10
Installation	12

# INSTRUCTIONS TO END-USERS

Read this Manual carefully before using the air conditioner to ensure proper operation of the units.

## INSTRUCTIONS TO INSTALLATION

- Make sure that our Co. after-sale service persons or technicians from our Co. or authorized maintenance shops do the installation for you.

Do not install the units at places where there might be leakage of inflammable gases.



In the case that the gases are leaked out and accumulated around the machine, it might result in fire hazards or other accidents.

Make sure that breaker is installed for safe operations.

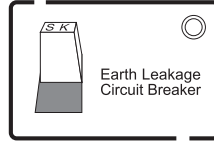

If breaker is not installed, it might result in electric shock or other hazards.

Make sure that the power source of the units is properly grounded.

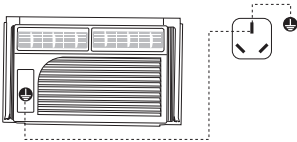

The grounding wire of the air conditioner must be firmly connected to the grounding wire of the power source. Improper grounding will lead to possible electric shock or other hazards.

## INSTRUCTIONS TO OPERATIONS

Do not try to stop the operation of the air conditioner by pulling the power cable from the socket.



It might result in electric shock, fire hazard or other accidents.

Do not plug the power source cable of the air conditioner to a connecting socket. Prolonged power cable or sharing the same socket is not allowed.

Do not use an extension cord.



It might result in electric shock, overheating, fire hazard or other accidents.

Do not press, stretch, damage, heat or modify the power cable.



It might result in electric shock, overheating, fire hazard or other accidents. In the case that the power cable is damaged or that a replacement for the power cable is needed due to some other reasons, please ask the our Co. dealer or authorized maintenance people to do the replacement.

Do not operate the power switches of the air conditioner by wet hands.



It might lead to electric shock or other hazards.

Make sure that there is no dust on the plug before you plug in the power socket and make sure the plug is well into the socket.

If there is dust on the plug or the plugging is not properly done, it might lead to electric shock, fire hazards or other accidents.



Do not use the fuse with improper capacity or other metal wires.

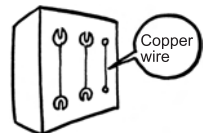

Improper use of metal wires or copper wires for fuse may result in faulty performances of the machine or fire hazards.

# INSTRUCTIONS TO END-USERS

Try as much as possible to avoid the sunlight and warm air from entering the room.



During the cooling operation, window curtains or louver blinds are to be used to shade off the sunlight.

Try to reduce the generation of heat in the room during cooling operations. Place the heating source outside of the room, if possible, do not use burning appliances in the air-conditioned room.



It might lead to the incomplete burning of these appliances.

If the air conditioner and the burning appliances have to be used in the same room, try to get good ventilation of the room.

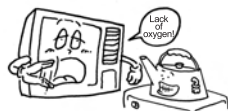

Insufficient ventilation might lead to the hazard of anoxia.

Do not place such articles as insecticides, paints or other flammable spraying agents near the air conditioner or spray them against the air conditioner.



It might result in fire hazards.

Do not insert sticks or other hard objects into the air inlet or outlet.

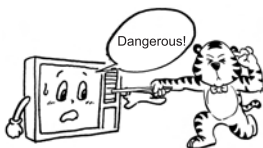

The high-speed rotation of the fan blades may cause accidents.

Do not wash the air conditioner with water.



It may cause electric shock or other accidents.

Do not use the following articles:



Warm water (above 40°C or 104°F)  
Warm water might cause deformation or fading of colors of the air conditioner.  
Gasoline, paint diluting agent, benzene and abrasives, etc. may cause deformation or scratches to the air conditioner.

Do not let the delivered air blow to your body directly for long time.



It might cause discomfort of your body or harm your health.

If the air conditioner is not to be used for a long period of time, please pull out the plug from the power source socket to ensure safety. Turn off the air conditioner before pulling out the plug.



## INSTRUCTIONS FOR REMOVAL AND REPAIRS

- If the units need to be removed for installation elsewhere or for repairs, please contact our Co. dealer or authorized maintenance shop technicians to do the job.
- In case of occurrence of abnormality (burning smell, for example), please stop the operations, disconnect the power and contact our Co. dealer or authorized maintenance shop.

# NOMENCLATURE AND FUNCTIONS OF VARIOUS PARTS

## FEATURES

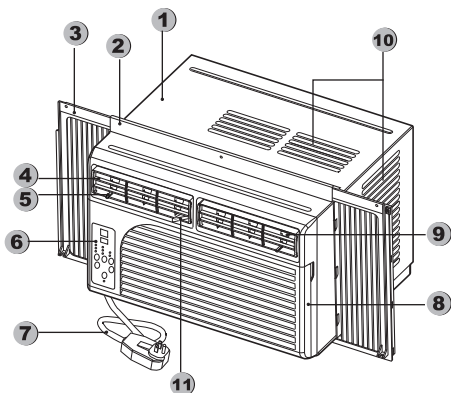

- 1 Cabinet
- 2 Upper guide
- 3 Curtain(window filler)
- 4 Up/down air direction flap
- 5 Left/right air direction control tab
- 6 Operation panel
- 7 Power cord
- 8 Front grille
- 9 Left/right air direction fin
- 10 Air inlet
- 11 Fresh air switch(optional,some models are not supplied with this)

Features and appearance will vary,all the figures provide a demonstration to introduce the funtion. The followings are two types of operation panels, Please check to refer the instructions for the identical operation panel of your air-conditioner.

## OPERATION PANEL 1

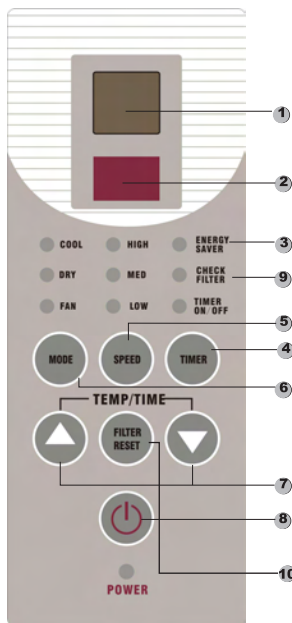

- 1 **DIGITAL DISPLAYER**  
In usual operation,In FAN mode,It indicates room temperature;In COOL or DRY mode,It indicates setting temperature;In timer operation,when pressing the timer button ,it indicates timer time,if the time has not been be adjusted after 5 seconds,it indicates temperature again;If ROOM TEMP SENSOR failure,It indicates temperature at 25℃ (77°F).
- 2 **REMOTE CONTROLLER SIGNAL RECEIVER**
- 3 **ENEREY SAVER**  
Fan operation shall occur in conjunction with compressor operation, the closing of Fan delay 1 min after compressor off,when compressor is off, fan stops for 10 minutes to open 20 seconds period run until compressor is on; other function same with the cooling function
- 4 **TIMER button**  
If unit is running,Press this button will enter Switch-OFF mode;If unit is off(in standby mode),Press this button will enter Switch-ON mode.Press this button again will cancel the timer operation.Used together with ▲ or ▼ button to set the timer time.
- 5 **SPEED button**  
Press this button to set air rate you want:HIGH,MED,LOW.
- 6 **MODE button**  
Press this button,it advances the operation mode as follows:ENERGY SAVER-DRY-FAN(heating for cooling and heating model)-COOL

# NOMENCLATURE AND FUNCTIONS OF VARIOUS PARTS

## 7 TEMP/TIME button

In usual, press this button to adjust setting temperature within a range of 16°C (61°F) to 32°C (90°F). In timer time setting state (press timer button to enter and "hr" indicator on right bottom of the digital display will be flashing), press ▲ or ▼ button to set the timer time within 1-24 hours.

Regard less of the display status, press the "▲" and "▼" button at the same time, to switch celsius/Fahrenheit display.

## 8 ON/OFF button

To turn the air conditioner ON, press the button and the power indicator will light. To turn the air conditioner OFF, press the button again.

## 9 CHECK FILTER

Filter cleaning machine works for 250 hours, "CHECK FILTER" LED light, reminds needing cleaning the filter.

## 10 FILTER RESET button

Press "FILTER RESET" button, and retiming, "CHECK FILTER" LED lights will go out.

## OPERATION PANEL 2

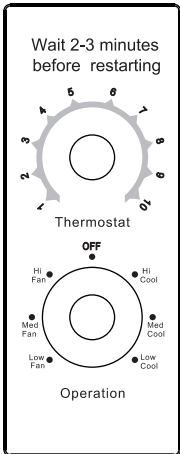

**Note: The layout and functions of various models of operation panels may differ from each other. Please read the following for your reference, and refer to using.**

## OPERATING METHOD FOR FUNCTIONAL CONTROL KNOBS

These knobs are used to control the rotating speed of the fan motor or the operation mode of the air conditioner.

- When the knob is turned to "**Low Fan**", the air conditioner will enter the ventilation mode of operation with weak airflow delivery, but the compressor is not activated.
- When the knob is turned to "**Med Fan**", the air conditioner will enter the ventilation mode of operation with strong airflow delivery, but the compressor is not activated.
- When the knob is turned to "**Hi Fan**", the air conditioner will enter the ventilation mode of operation with stronger airflow delivery, but the compressor is not activated.

- When the knob is turned to "**Low Cool**", the air conditioner will be in low cooling operation mode to delivery weak airflow.
- When the knob is turned to "**Med Cool**", the air conditioner will be in medium cooling operation mode to delivery strong airflow.
- When the knob is turned to "**Hi Cool**", the air conditioner will be in high cooling operation mode to delivery stronger airflow.
- When the knob is turned to "**OFF**", the air conditioner will stop operation.

Note: When the knob is to be turned, try to turn it as slowly as possible and not to turn it frequently. The time interval for re-activation must be no less than 3 minutes so as to avoid overload to the unit, which might cause fuse blown.

## OPERATING METHOD OF TEMPERATURE CONTROL KNOB

The temperature can be set within a range of 18°C (64°F) to 32°C (90°F). The temperature is to be reduced from 1 to 10. Turn the knob to adjust the needed temperature.

# USE OF REMOTE CONTROLLER

## REMOTE CONTROLLER

- Note: 1. Only some model air conditioners are supplied with a remote controller.  
2. There are two types of remote controllers, Please check to refer the instructions for the identical remote controller of your air-conditioner.

## REMOTE CONTROLLER 1

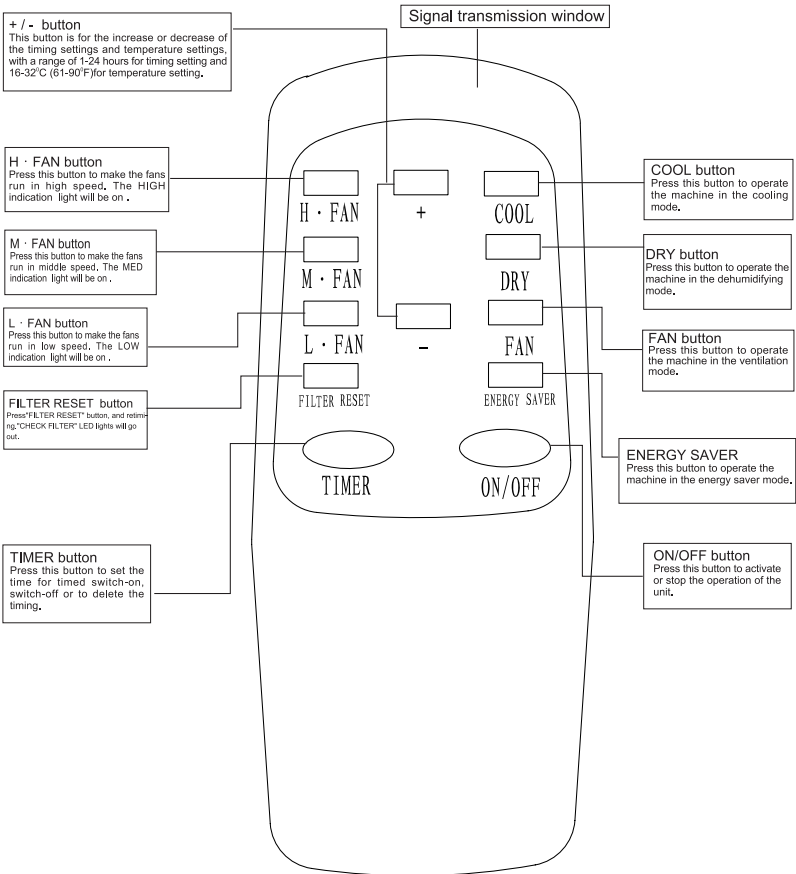

# USE OF REMOTE CONTROLLER

## METHOD OF TRANSMISSION

- Point the remote controller at the air conditioner as shown in the figure and press the button on the controller. The instruction signal will be transmitted to the air conditioner.
- Upon receiving the signal from the remote controller, the air conditioner unit will utter a "dee-" sound for acknowledgment.

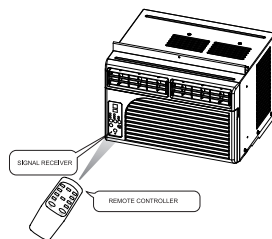

## POINTS OF ATTENTION IN USING THE REMOTE CONTROLLER

- Do not place the controller near something with high temperature like an electric heating bed cushion or a heating radiator;
- Do not place the controller at places directly exposed to the sunlight or strong lights;
- Avoid accidental dropping of the controller, which might cause damage to it;
- Do not place blocking objects between the air conditioner and the controller;
- Do not splash water or other liquids to the controller;
- Do not put heavy objects on the controller;
- If the air conditioner unit does not utter the acknowledging sound after proper signals are transmitted, it shows the batteries in the controller are exhausted and need replacing.
- If the remote controller is not functioning, replace the batteries and try once again.

## REPLACEMENT OF BATTERIES

**When the signal is transmitted but the air conditioner does not give an acknowledgment sound. It means the batteries are exhausted and need replacements.**

1. Remove the battery case cover and take the used batteries out by sliding the cover open in the arrow direction.
2. Replace with new batteries and pay attention to the "+" and "-" marks of pole indications.
3. Close the back cover.

## ADJUSTMENT OF AIR DIRECTION

### Up/down adjustment:

Hold the up/down air flap at proper position by hand and move it upward or downward for adjustment.

### Left/right adjustment:

Push left/right air direction control tab to adjust the left/right air direction.

## ADJUSTMENT OF AIR EXCHANGE

**Note:**This air exchange adjustment is just suitable for those models with fresh air function.

When you want to get fresh air, push the fresh air lever backward by hand, pull the lever forward, the fresh air function is closed.



# METHODS OF MAINTENANCE

★ Before doing the maintenance, make sure that the air conditioner is turned off and the plug is pulled out from the socket.

## Before the operational seasons

**1** Check to see if there are any blocking objects around the air inlet and outlet of the indoor and outdoor units.

**2** Check to see if the installation base is corroded or rusty.

**3** Check if the grounding is properly made.

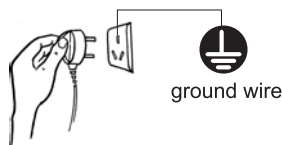

**4** Check if the air filter screen is clean.

**5** Connect to the power source

**6** Load batteries in the remote controller. (remote controller model)

## After the operational seasons

**1** Set the temperature at 30°C(86°F) and let the machine run in cooling mode for half a day. Make the interior of the units dry.



**2** Stop the operation of the machine and turn off the power switch.

It is recommended to pull the plug from the power socket in the non-operational season for the sake of safety and saving energy.



**3** Clean the air filter screen and install it back to place.

**4** Clean the indoor unit and outdoor unit.



**5** Take the batteries out from the remote controller. (remote controller model)

## During the operational seasons

Clean the air filter screen (at a standard interval of once every two weeks).

**1** Remove the air filter screen

1) Gently hold and press the two lower ends of the front grille and open the grille.

2) Gently grab the air filter screen and lift it up, and then take it out in the direction toward you.

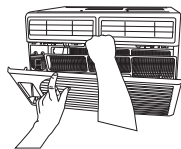

**2** Clean the air filter screen

If the air filter screen is very dirty, you may use lukewarm water (about 30°C(86°F)) to clean it, and then air it dry.

**N.B:**

- Do not use boiling water to clean the screen.
- Do not bake the screen dry.
- Do not pull it with too much force.

**3** Install the air filter screen.

If the air conditioner is operated without an air filter screen, the interior of the unit will be contaminated by dirt which might cause performance failure or even damage of parts.

**4** Clean the air conditioner

- Use soft dry cloth to wipe the air conditioner or use a vacuum cleaner to do the cleaning.
- If the air conditioner is very dirty, you may use a piece of cloth soaked with household neutral detergent to do the cleaning.



**N.B:**

If the air filter screen is blocked by dust, the performance of cooling and heating operations will be affected, the operational noise will be larger and the power consumption will be increased. Therefore, periodic cleaning of the air filter screen is necessary.

# DIAGNOSIS ON PHENOMENA AND TREATMENTS

## Inspection and treatment prior to maintenance

Please check the following items before asking our Co. dealer or authorized maintenance shop for after-sale services:

### The air conditioner does not work at all.

Is the power plug inserted into the socket properly?

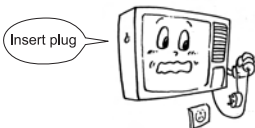

Is there a power failure or is the fuse blown?

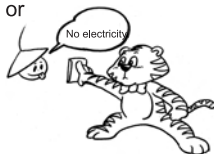

Is the timer set for the "TIMER-ON" mode?

If the air conditioner is set for timed switch-on operation mode, it will not start operating before the set time is reached.

Is the ambient temperature lower than 16°C or 61°F?

If so, the auto protection function of the air conditioner will prevent the unit from cooling operation.

### There is no sufficient cooling or heating.

Is the room temperature set properly?



Is the air filter screen clean (not blocked)?

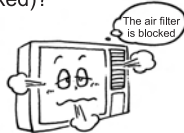

Are the doors or windows opened?



Is the room directly exposed to sunlight?



Are there any heating sources inside the room?



Are there many people inside the room?



**Note:** If the air conditioner remains abnormal in operation after the above checks and inspection, please disconnect the power and contact the our Co. dealer or the authorized maintenance shop.

In any of the following cases, please turn off the power of the air conditioner and immediately contact the dealer or the authorized maintenance shop:

The fuse is frequently blown or the breaker is often off.

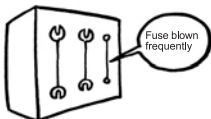

The electric wire turns abnormally hot.



The insulation sheath of the power cable is torn.





The switches do not work.

There are abnormal noises when the machine is operating.

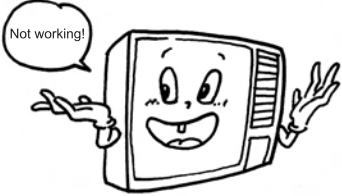
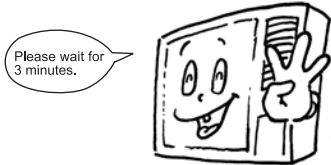

# DIAGNOSIS ON PHENOMENA AND TREATMENTS

The following phenomena occurring during the operation do not mean faults of the machine. You may use the air conditioner with peace of mind.

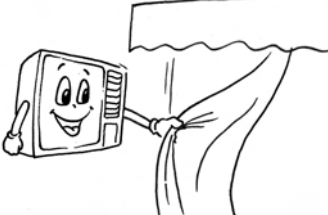
Phenomena	Diagnosis
<p>The air conditioner cannot be started for operation after it is turned off.</p> 	<p>Start the operation after 3 minutes. This is to protect the air conditioner.</p>  <p>The microchip protection device for 3 minutes' delay performs its function. When the machine is powered for the first time, this function does not work.</p>
<p>Fog is blown out during the cooling operation.</p>	<p>When the indoor temperature and humidity is high, such phenomena might occur. When the indoor temperature and humidity drops, the fog will disappear.</p>
<p>There is odd smell of the delivered air.</p>	<p>It might be the smell of cigarette smoke or other things inside the air conditioner.</p>
<p>There is "squeezing" sound.</p>	<p>It might be caused by the cycling of the refrigerant inside the air conditioner.</p>
<p>There is "patting" sound.</p>	<p>It might be caused by the heat expansion of contraction of the plastic parts.</p>
<p>The operation cannot be resumed even the power is turned on after the power switch is turned off or after the power supply is off. (remote control model)</p>	<p>The memory of the microchip computer is deleted. Operate the remote controller to re-start the operation. (remote control model)</p>
<p>No remote control signal is received.</p> 	<p>When the signal receiver on the air conditioner is exposed to sunlight or strong lights, it might fail to receive the remote control signal.</p>  <p>Shade off the sunlight or fade the lighting in this case.</p>
<p>There is moisture at the air outlet grids.</p>	<p>If the air conditioner operates in high humidity for long time, moisture may be condensed at the grids and become water drops.</p>

# INSTALLATION

## INSTALLATION REQUIREMENTS

This room air conditioner is designed for installation in standard double-hung windows with actual opening widths from 23" to 36" (584 mm to 914 mm) (FIG. 1).

Lower sash must open sufficiently to allow a clear vertical opening of 14-1/2" (368mm). Side louvers and the rear of the air conditioner must have clear air space to allow enough airflow through the condenser for heat removal. The rear of the unit must be outdoors, not inside a building or garage.

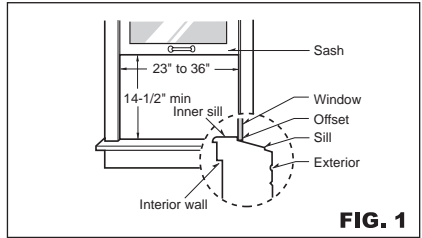

FIG. 1

## INSTALLATION HARDWARE

Before doing the installation, please check to see if the installation accessories are complete (FIG.2). You must have the Phillips screwdriver tools available for installation.

ITEM	NAME OF PARTS	Q'TY
A	SHORT SCREWS	8
B	WOOD SCREWS	12
C	UPPER GUIDE	1
D	INSERT STRIP	1
E	CURTAIN	2
F	CURTAIN LOCK	2
G	SASH LOCK	2
H	FOAM SEAL	1

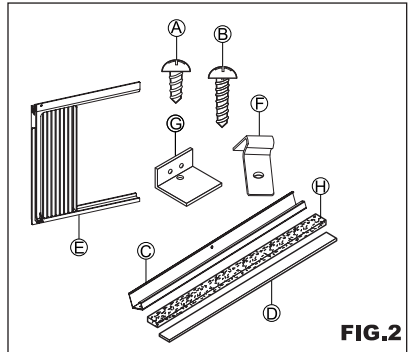

FIG.2

## INSTALLATION POSITION

Pick a location which will allow you to blow the cold air into the area you want. Windows used for installation must be strong enough to support the weight of the air conditioner. Good installation with special attention to the proper position of the unit will lessen the chance that service will be needed.

## HOW TO INSTALL

### 1 UPPER GUIDE

- Remove the air conditioner and upper guide from the carton, place them on a flat surface.
- Align the hole in the upper guide with those in the top of the unit.
- Secure the upper guide to the unit with 3/8" short screws as shown in FIG.3.

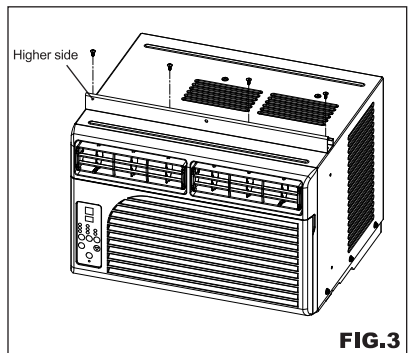

FIG.3

Note: Higher side of the upper guide to be facing the room side.

# INSTALLATION

## 2 CURTAIN (WINDOW FILLER )

NOTE:Upper guide and curtain at each side are offset to provide the proper pitch to the rear of the unit.This is necessary for proper condensed water utilization and drainage.

- Insert the side curtains into the upper and lower guides of the air conditioner. Fasten the curtains to the the unit with screws as shown in FIG.4.  
There is a left and a right crutain, be sure to use the proper curtain for each side. Hold the according curtain in one hand and gently pull back the center to free the open end. See FIG.4.(When installed the flange for securing the curtain into the window sill will be facing the room side.)

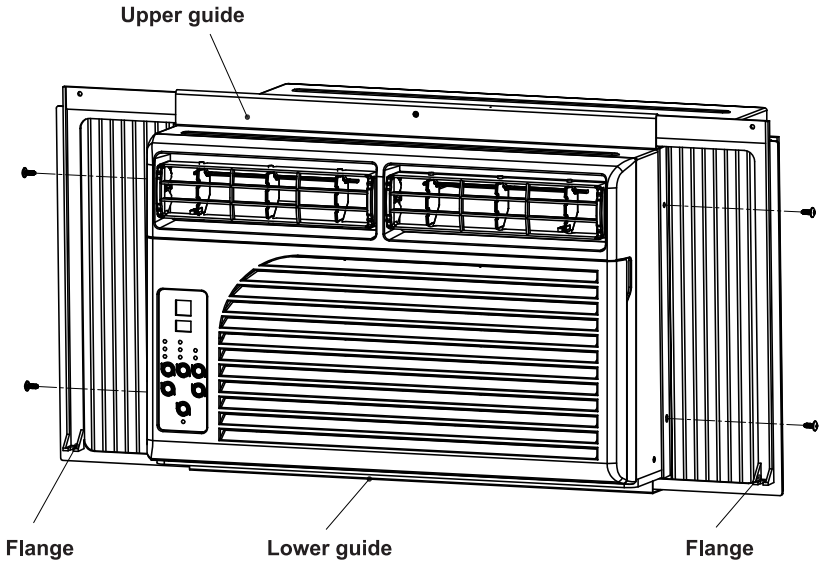

FIG.4

# INSTALLATION

## 3 INSTALL THE AIR CONDITIONER IN THE WINDOW

- Carefully lift air conditioner and place the unit into the window opening so the bottom of the air conditioner frame is against the window sill. Carefully close the window behind the upper guide of the unit.

## 4 SECURE THE AIR CONDITIONER (FIG.5)

- Extend the curtain panels to fill the window opening.
- Place the curtain lock between the curtain extensions and the window sill, drive locking screws through the lock and into the sill.
- Secure the left and right flanges on end bottom side of the panel with wood screws.
- Drive locking screws through upper frame holes into window sash.
- Attach the sash lock to the place between the upper and lower sashes and secure it with screws.
- Finally, cut the foam seal to the window width and stuff the sash seal between the glass and the window to prevent air and insects from getting into the room.

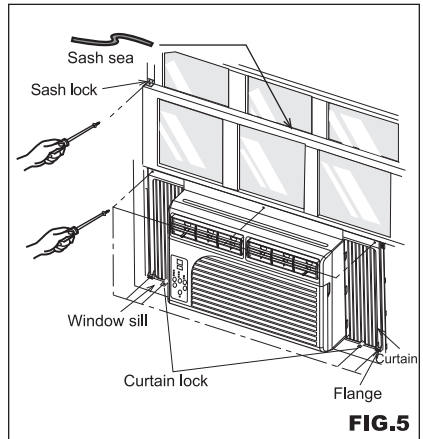

FIG.5

## 5 TEST RUNNING

- Connect to power source, check to see if the operational mode buttons work properly.
- Check to see if the room temperature control and the function controls work properly.
- Check if there are any abnormal sounds during operations.

## IF AC IS BLOCKING BY STORM WINDOW

- Add woods as shown in FIG.6, or remove storm window before air conditioner is installed.
- If storm window frame must remain, be sure the drain holes or slots are not caulked or painted shut. Accumulated rain water or condensation must be allowed to drain out.

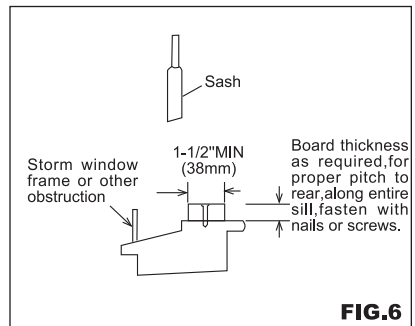

FIG.6

# INSTALLATION

## REMOVAL FROM WINDOW

- Turn AC off, and disconnect power cord.
- Remove sash seal from between windows, and unscrew sash lock.
- Unscrew curtain lock and remove screws installed through curtain.
- Close curtain panels into frame.
- Keeping a firm grip on the air conditioner, raise the sash, and carefully tilt the air conditioner backward, draining any condensate water in the base of unit. Be careful not to spill any remaining water while lifting unit from window.
- Store parts with air conditioner.

## CAUTION FOR DISMANTLING THE AIR CONDITIONER (It is just suitable for those models with fresh air function)

- If you purchase the models with fresh air function, while dismantling the air conditioner to repair the inner parts (such as condensator, evaporator, copper pipe etc.), be sure to first remove the air-guide frame, pull upward the fresh air lever to make it disengage from its place (FIG.7), and then continue the other dismantling work.

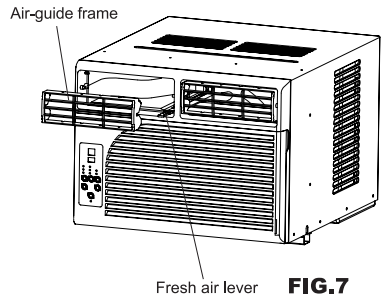

**FIG.7**

